

MINDEO

ME5000+ Barcode Image Engine User Manual



Version: ME5000+_UM_EN_V1.1.1

Contents

Notes about structure and electric circuit design.....	v
1 Specifications.....	1
1-1 Technical specifications	1
1-2 Default setting for each barcode	3
2 Get started.....	5
2-1 Overview.....	5
2-2 Electrical interface/Pin assignment	6
2-3 Typical input/output, LDO external, and DC/DC circuitries.....	8
2-4 Power management	9
2-5 Installation guide.....	10
2-5-1 Mounting	10
2-5-2 Scan window materials.....	14
2-5-3 Scan window positioning	14
2-6 Notes of timing.....	15
2-6-1 Timing characteristics	15
2-6-2 Timing waveforms.....	15
2-7 Operation of engine.....	16
2-7-1 Example 1: Request revision.....	16
2-7-2 Example 2: Decode by pulling down pin TRIG.....	17
2-7-3 Example 3: Decode by commands	18
3 Parameter Menus.....	20
3-1 Introduction.....	20
3-2 Example 1: Single-parameter setting by scanning 1D barcodes.....	21
3-3 Example 2: Multiple-parameter setting by scanning a QR code barcode	22
3-4 RS-232 interface.....	23
3-5 USB interface	26
3-6 Scan mode & some global settings.....	29
3-7 Indication	35
3-8 Decode illumination mode and decode aiming pattern.....	37
3-9 Single type of barcode, Multi-symbols, and Vertical centering read.....	39
3-10 UPC-A.....	42
3-11 UPC-E	44
3-12 UPC-E1.....	46
3-13 EAN-13	48
3-14 EAN-8	50
3-15 Code 39 (Code 32, Trioptic Code 39)	52
3-16 Interleaved 2 of 5.....	55
3-17 Industrial 2 of 5.....	57
3-18 Matrix 2 of 5.....	58
3-19 Codabar	60
3-20 Code 128.....	62
3-21 UCC/EAN 128 (GS1-128)	64
3-22 ISBT 128.....	66
3-23 Code 93	68
3-24 Code 11	70

3-25 MSI/Plessey.....	72
3-26 UK/Plessey	74
3-27 China Post.....	76
3-28 China Finance	77
3-29 GS1 DataBar (GS1 DataBar Truncated).....	79
3-30 GS1 DataBar Limited	80
3-31 GS1 DataBar Expanded.....	81
3-32 GS1 Composite	82
3-33 PDF417.....	84
3-34 MicroPDF417.....	85
3-35 QR Code.....	86
3-36 Micro QR	87
3-37 Data Matrix	88
3-38 Han Xin Code	89
3-39 Aztec Code	90
3-40 G1-G6 & C1-C2 & FN1 substitution string setting	91
3-41 G1-G4 string position & Code ID position	96
3-42 String transmission	97
4 Serial Communication Interface (SCI).....	100
4-1 Programming command syntax.....	101
4-1-1 Single-parameter setting	101
4-1-2 Multiple-parameter setting.....	102
4-1-3 Query command syntax.....	102
4-1-4 Start Decode & Stop Decode.....	103
4-1-5 Return default parameters & firmware revision.....	103
4-1-6 Get Image	104
4-1-7 Responses.....	104
4-2 Examples of setting and query commands	105
5 ASCII table	107
6 Barcode representing non-printable character	108
7 Test barcode symbols	109
8 Enable & Disable configuration by scanning barcode	112
9 Return default parameters & firmware version	113
10 Configuration alphanumeric entry barcode	114

Notes about structure and electric circuit design

1. Read [2-1 Overview](#) carefully to learn about the decomposition diagram of the engine.
2. Read [2-2 Electrical interface/Pin assignment](#) carefully to learn about the electrical interface design.
3. The engine must be electrically isolated. In a radio system if antennas are located closely to the engine, the performance reduction of engine can exist.
4. For an electromagnetic compatibility system, the positioning of the 25-pin FPC cable (cable of optics module) is important.
5. Leave sufficient space to accommodate the maximum size of the engine.

1 Specifications

1-1 Technical specifications

Dimensions	Optics Module: 11.6 mm × 19.2 mm × 10.6 mm Decoder Board: 31.2 mm × 19.2 mm × 5.4 mm		
Weight	Optics Module: 4.0 g, decoder board: 3.0 g		
Interface Supported	TTL-232, or Micro USB		
Indicator Interface	To control external Beeper and LED		
Cable	Tapered 12-pin flex strip (12 × 0.5 mm), or Micro USB cable		
Scanning Mode	Good-Read off, Momentary, Alternate, Continuous, Time-Out Off, Host, Auto-induction		
Programming Method	Scanning special barcodes in sequence, or sending commands		
Firmware Upgrade	Online		
Input Voltage	TTL-232: 3.3 ± 5% VDC, Micro USB: 5.0 ± 5% VDC		
Current	TTL-232: 18 mA (sleeping), 65 mA (idle), 325 mA (scanning) Micro USB: 60mA (idle), 240 mA (scanning)		
Illumination LED	White emitting color, 2700K		
Aiming	525 nm peak wavelength, green LED		
Image Size	640 × 480 pixels		
Scanning Angles	±58°, ±65°, 360° (skew, pitch, roll)		
Field of View	Horizontal: 48°, vertical: 38°		
Print Contrast	20% minimum reflectance difference		
Decoding Capability	<p>1D: UPC-A, UPC-E, UPC-E1, EAN-13, EAN-8, ISBN (Bookland EAN), ISSN, Code 39, Code 39 full ASCII, Code 32, Trioptic Code 39, Interleaved 2 of 5, Industrial 2 of 5, Matrix 2 of 5, Codabar (NW7), Code 128, ISBT 128, Code 93, Code 11 (USD-8), MSI/Plessey, UK/Plessey, UCC/EAN 128 (GS1-128), China Post, China Finance, GS1 DataBar (formerly RSS) variants</p> <p>2D: PDF417, MicroPDF417, QR Code, DataMatrix, Han Xin Code, Aztec Code, GS1 Composite</p>		
Minimum Resolution	1D: 5 mil Code 39, 2D: 6.7 mil PDF417		
Decoding Depth		General Area (GA)	Wide Area (WA)
	5 mil Code 39 (3 chars)	20 – 45mm	20 – 40mm
	10 mil Code 39 (3 chars)	15 – 140mm	12 – 95mm
	13 mil UPC (6 chars)	15 – 170mm	12 – 115mm
	15 mil Code 39 (1 char)	15 – 235mm	12 – 165mm
	20 mil Code 39 (1 char)	20 – 365mm	15 – 285mm
	6.7 mil PDF417 (20 chars)	20 – 75mm	15 – 50mm
	10 mil QR (20 chars)	15 – 90mm	12 – 45mm
	10 mil DM (20 chars)	15 – 85mm	12 – 45mm
	20 mil QR (20 chars)	12 – 200mm	15 – 140mm
Temperature	Operating: -10°C to 45°C (-14°F to 113°F) Storage: -20°C to 70°C (-4°F to 158°F)		
Humidity	5% to 95% (non-condensing)		
Mechanical Vibration	IEC60068-2-6		

	<p>Un-powered engine withstands a random vibration along each of the X, Y and Z axes for a period of one hour per axis, define as follows:</p> <p>20 to 80 Hz Ramp up to 0.04 G²/Hz at the rate of 3 dB/oct</p> <p>80 to 350 Hz 0.04 G²/Hz</p> <p>350 to 2000 Hz Ramp down at the rate of 3 dB/oct</p>
Mechanical Shock	<p>IEC60068-2-27</p> <p>Shock pulse: 0.5 ms, Maximal acceleration: 1500 G, Shock direction & time: ±X-axis, ±Y-axis, ±Z-axis, 3 times for each direction, total of 18 times.</p>
Safety	<p>Photobiological Safety: EN62471:2008</p> <p>EMC: EN55022</p> <p>ESD Protection: EN55024</p> <p>RF Immunity: IEC61000-4-3, 10 V/m</p> <p>Artificial light Immunity: 100,000 lux</p>

1-2 Default setting for each barcode

Code type	Read enable	Check digit verification	Check digit transmission	Min. code length	Proprietary code ID	AIM code ID
UPC-A	√	√	√	(12) ²	A	JEm
UPC-E	√	√	√	(8) ²	D	JEm
UPC-E1	-	√	√	(8) ²	D	JX0
EAN-13	√	√	√	(13) ²	A	JEm
EAN-8	√	√	√	(8) ²	C	JE4
ISBN (Bookland EAN)/ISSN ¹	√	√	√	(13) ²	B	JEm
Code 39	√	-	-	1	M	JAm
Interleaved 2 of 5	√	-	-	6	I	JIm
Industrial 2 of 5	-	-	-	4	H	JS0
Matrix 2 of 5	√	-	-	6	X	JX0
Codabar	√	-	-	4	N	JFm
Code 128	√	√	-	1	K	JCm
UCC/EAN 128 (GS1-128)	√	√	-	1	K	JCm
ISBT 128	√	√	-	1	K	JCm
Code 93	√	√	-	1	L	JGm
Code 11	-	√	-	4	V	JH3
MSI/Plessey	-	-	-	4	O	JMm
UK/Plessey	-	√	-	1	U	JMm
China Post	√	-	-	(11) ²	T	JIm
China Finance	√	-	-	(10) ²	Y	-
GS1 DataBar	√	-	-	(16) ²	R	Jem
GS1 DataBar Truncated ³	√	-	-	(16) ²	R	Jem
GS1 DataBar Limited	√	-	-	(16) ²	R	Jem
GS1 DataBar Expanded	√	-	-	1	R	Jem
GS1 Composite	-	-	-	-	y	Jem
PDF417	√	-	-	-	p	JLm
MicroPDF417	-	-	-	-	p	JLm
DataMatrix	√	-	-	-	d	Jdm
QR code	√	-	-	-	q	JQm
Micro QR code	-	-	-	-	q	JQm
Han Xin Code	-	-	-	-	h	JX0

Code type	Read enable	Check digit verification	Check digit transmission	Min. code length	Proprietary code ID	AIM code ID
Aztec Code	-	-	-	-	a]zm

Note: ¹The settings for ISBN/ISSN and EAN-13 must be the same except the code ID.

²Fixed-length symbols.

³The settings for GS1 DataBar Truncated and GS1 DataBar must be the same.

2 Get started

2-1 Overview

The engine is a CMOS imager-based module device for image capture and barcode decode. It supports reading 1D and 2D barcodes. Flexibility of integrating this engine into an OEM application is provided. It is configured as an optics module and a decoder board.

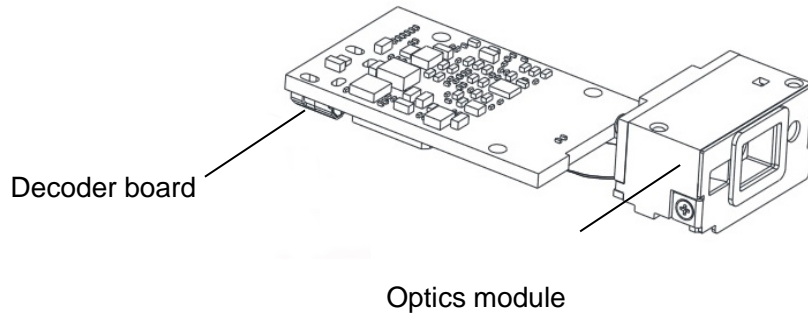

2-2 Electrical interface/Pin assignment

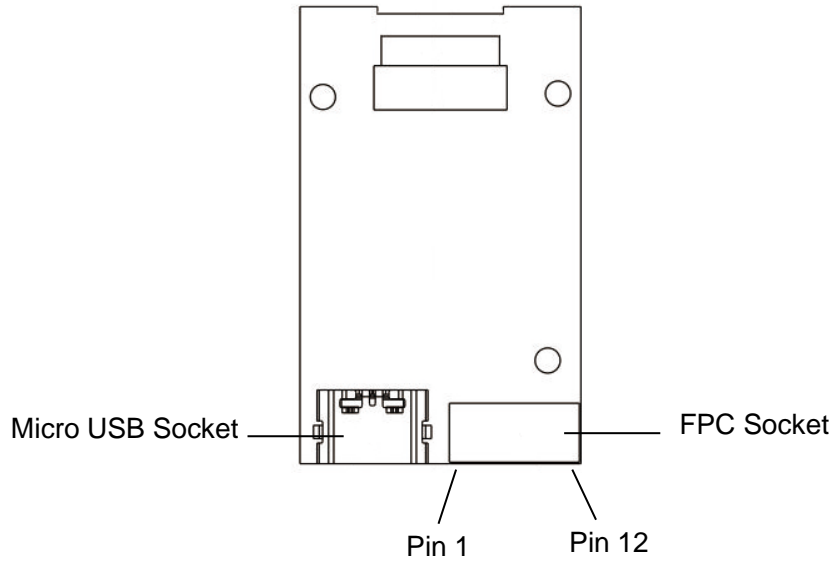

Table 2-1 lists the pin assignments of the engine.

Table 2-1 Electrical interface/Pin assignment

Pin No.	Signal Name	Type	Description
1	Flash_DWLD*	Input	Flash download. Pull low and power on, the engine will enter upgrade-ready mode.
2	VCC	Power	Power supply: 3.15 to 3.45 VDC.
3	GND	Power	Power/Signal Ground: 0 VDC reference.
4	RXD	Input	Received data: Serial data receive input port.
5	TXD	Output	Transmitted data: Serial data transmit port.
6	CTS*	Input	Clear-to-send: serial port handshaking line (input).
7	RTS*	Output	Request-to-send: serial port handshaking line (output).
8	PWRDWN	Output	Power down ready. When high, the engine is in low power mode (sleep mode).
9	BPR*	Output	Beeper. Low current beeper output.
10	DLED*	Output	Decode LED. Low current decode LED output.
11	WAKE*	Input	Wake up. When the engine is in low power mode, the falling edge of this pin awakens the engine.
12	TRIG*	Input	Trigger. Hardware triggering line, driving this pin low causes the engine to start an image capture and decode session.

Note: *=logic low. Signal names with the "*" modifier are asserted when at the ground level. Signals names without the "*" modifier are asserted when at the positive supply voltage level.

The engine has a TTL-level RS-232 interface to communicate with a host. The following diagram demonstrates the interconnection.

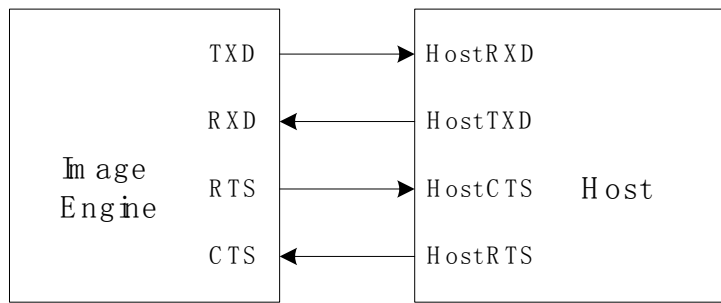
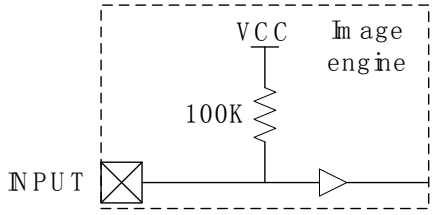
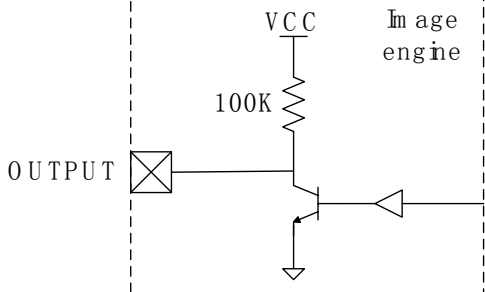
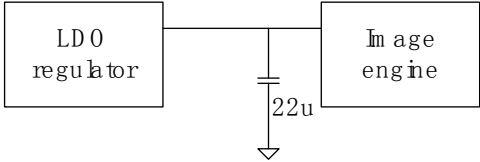
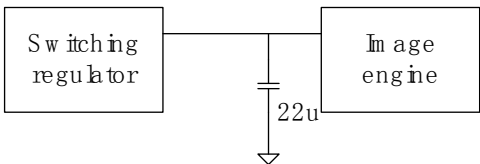

Figure 2-1 Engine and Host interconnection via RS232

RTS and CTS are only used for hardware flow control and should be leaved unconnected or tied to V_{CC} by 100K Ohm resistors when they are not used.

2-3 Typical input/output, LDO external, and DC/DC circuitries

<p>Input: each input IO pin is internally pulled up by a 100 K Ohm resistor. $V_{CC}=3.3$ V.</p> <table border="1" data-bbox="236 331 686 436"> <thead> <tr> <th></th> <th>Min.</th> <th>Max.</th> </tr> </thead> <tbody> <tr> <td>V_{inL}</td> <td>-0.3 V</td> <td>0.7 V</td> </tr> <tr> <td>V_{inH}</td> <td>2.4 V</td> <td>3.6 V</td> </tr> </tbody> </table>		Min.	Max.	V_{inL}	-0.3 V	0.7 V	V_{inH}	2.4 V	3.6 V	
	Min.	Max.								
V_{inL}	-0.3 V	0.7 V								
V_{inH}	2.4 V	3.6 V								
<p>Output: each output port is an open-drain pad with a 100 K Ohm pull-up resistor and the maximum sink current is 100 mA.</p>										
<p>External LDO circuitry: it is recommended to apply low noise LDO (Low Dropout Voltage) regulators.</p>										
<p>External switching regulator circuitry:</p> <table border="1" data-bbox="199 1232 726 1332"> <thead> <tr> <th></th> <th>Min.</th> <th>Max.</th> </tr> </thead> <tbody> <tr> <td>Switching Frequency</td> <td>1 MHz</td> <td>-</td> </tr> <tr> <td>Ripple V_{P-P}</td> <td>-</td> <td>50 mV</td> </tr> </tbody> </table>		Min.	Max.	Switching Frequency	1 MHz	-	Ripple V_{P-P}	-	50 mV	
	Min.	Max.								
Switching Frequency	1 MHz	-								
Ripple V_{P-P}	-	50 mV								

2-4 Power management

The engine has two power states: Awake Power state and Sleep Power state, refer to [Sleep mode](#) of [3-6 Scan mode & some global settings](#).



One of the wake-up methods listed in Table 2-2. Once the engine is awakened, at least 1 second must elapse before it re-enters Sleep Power state.

Table 2-2 Waking-up the engine

Signal	State to Wake-up
WAKE*	Falling edge.
TRIG*	Falling edge.
CTS*	Falling edge.
RXD	Send 0x00.
Signal names with the "*" modifier are asserted when at the ground level. Signal names without the "*" modifier are asserted when at the positive supply voltage level.	

When the engine is in Awake Power state, you can operate the engine anytime. When the engine is in the Sleep Power state, the PWRDWN signal is asserted. This makes the Low Power mode more suitable for battery powered applications. If you want to operate the engine, you need to wake up the engine firstly, for more wake-up methods, please see Table 2-2.

2-5 Installation guide

2-5-1 Mounting

Units = mm

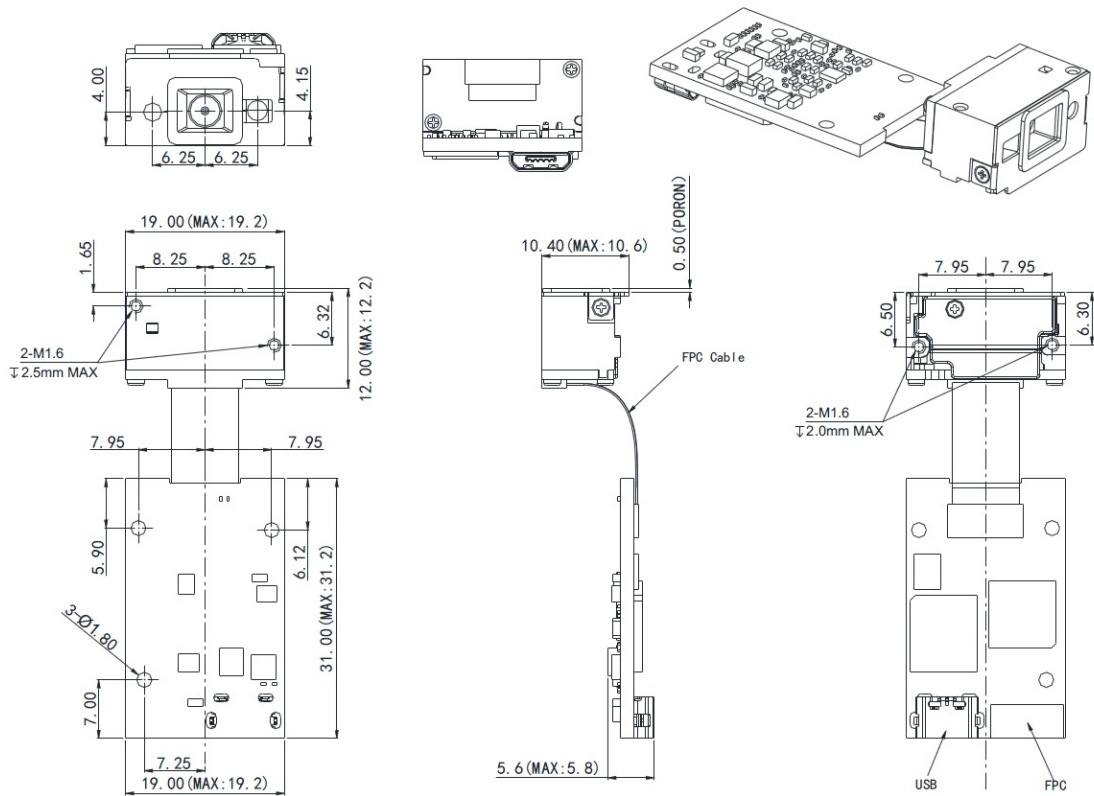

Figure 2-2 Separated Engine

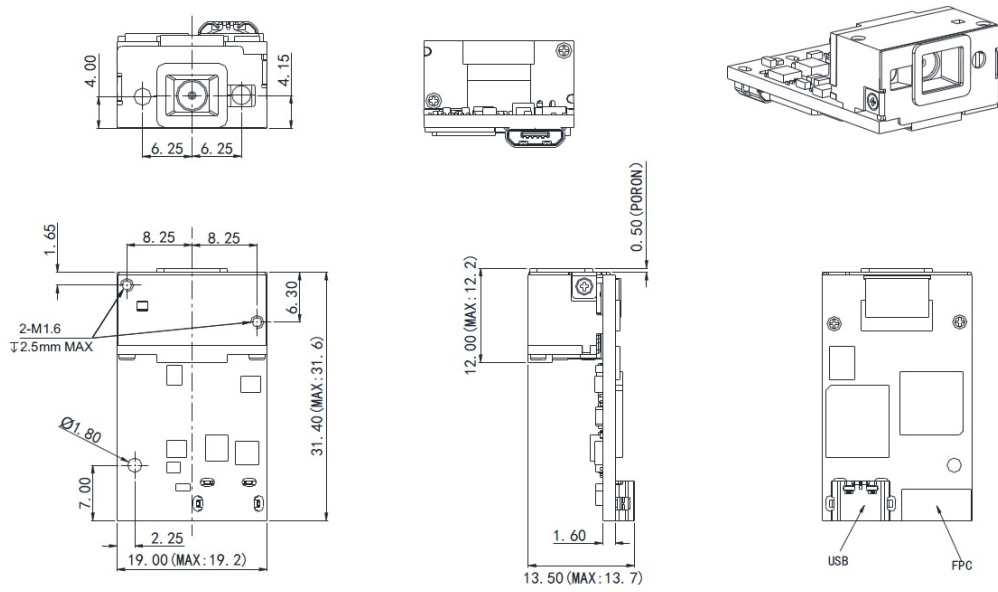

Figure 2-3 Combined Engine

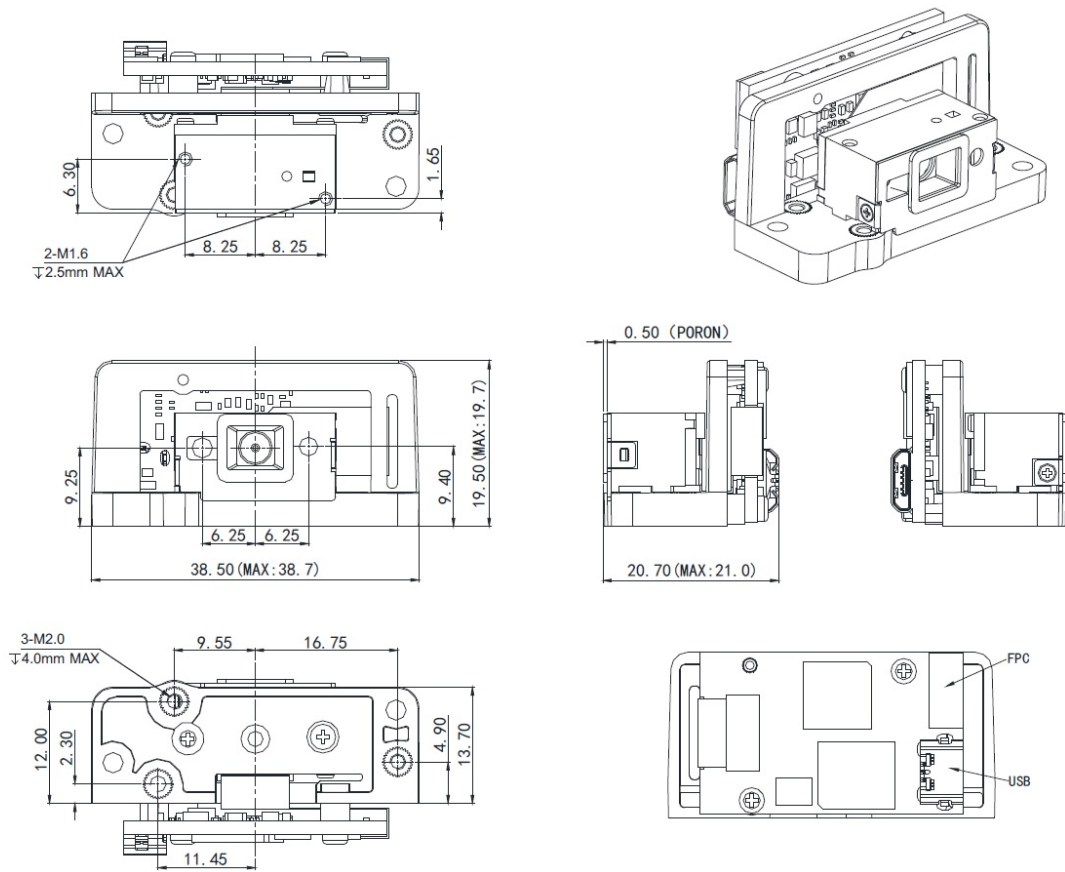

Figure 2-4 Engine with big bracket

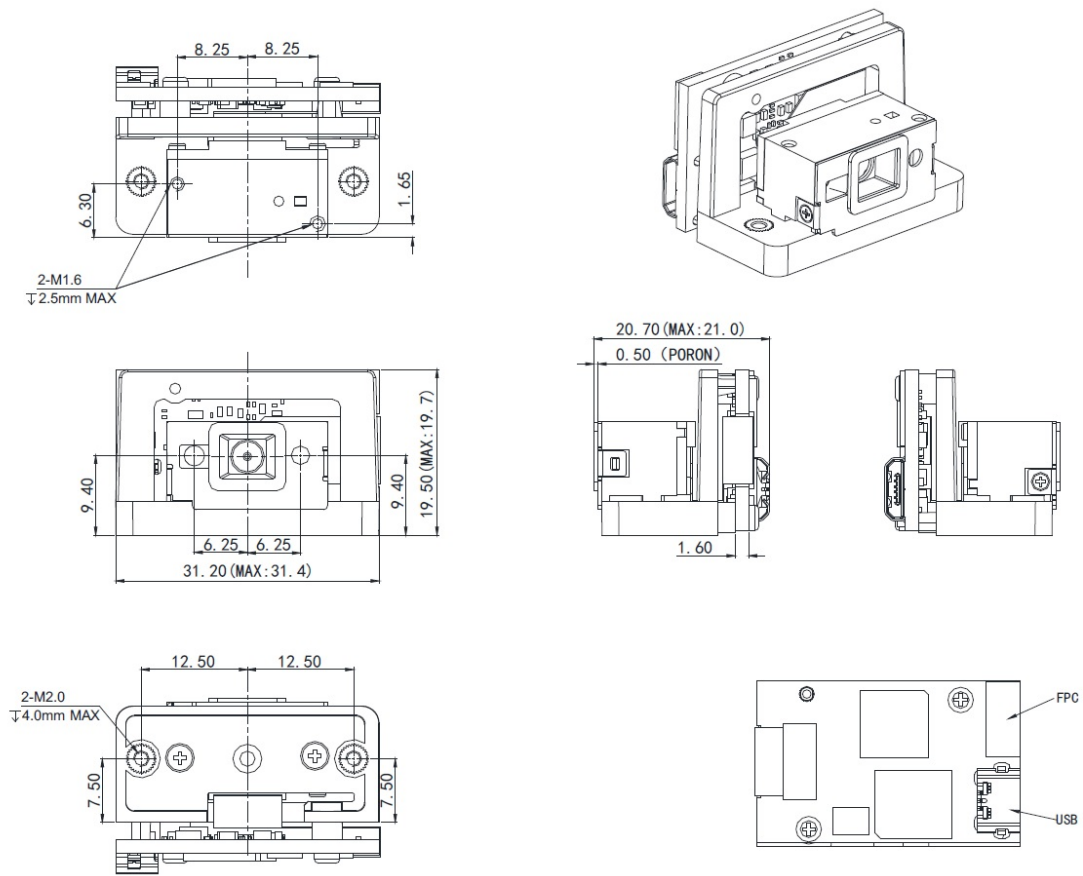

Figure 2-5 Engine with small bracket

2-5-2 Scan window materials

Many window materials that look perfectly clear to eyes can contain stresses and distortions which affect the optics module and reduce engine performance. Following are the description of three popular scan window materials:

- ✚ Poly-methyl Methacrylic (PMMA): Also known as Cell Cast Acrylic, and is relatively soft.
- ✚ Allyl Diglycol Carbonate (ADC): Also known as CR-39.
- ✚ Chemically tempered float glass.

Among these three materials, the chemically tempered float glass is a hard material which provides the most excellent scratch and abrasion resistance.

Note: The structure design must be well considered to pass drop test.

2-5-3 Scan window positioning

The following rules must be followed to avoid unwanted reflections occurred at either surface of the windows. A diagram is shown below for reference.

1. The distance from the optics module to the scan window should be as short as possible and cannot exceed 1.0 mm.
2. The distance from the front of the optics module to the far side of the glass should not exceed 2.5 mm.
3. The scan window should be fully parallel to the front of the optics module.

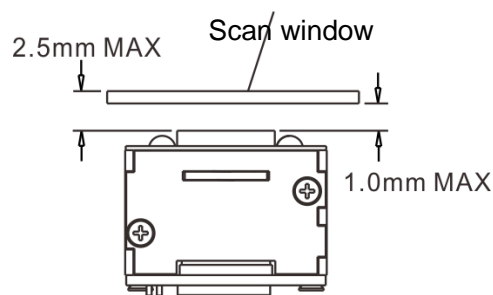

2-6 Notes of timing

2-6-1 Timing characteristics

Table 2-2 Timing characteristics

Symbol	Parameter	Conditions	Min.	Typ.	Max.	Unit
General characteristics						
t_f	High to low fall time	$C_L=50\text{pf}$			1.0	us
t_r	Low to high rise time	$C_L=50\text{pf}$			1.0	us
Trigger timing						
$t_{\text{trig_l}}$	Trigger low level hold time		20			ms
$t_{\text{trig_h}}$	Trigger high level hold time		20			ms
t_{dbt}	Trigger de-bounce time				1.1	ms
Wake up timing						
t_{slp2fo}	Sleep to full operation				25	ms

2-6-2 Timing waveforms

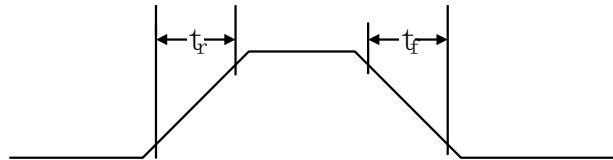

Figure 2-6 General characteristics

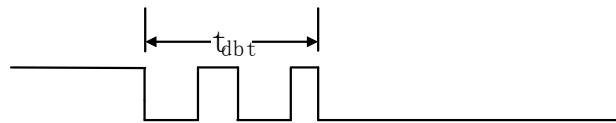

Figure 2-7 Trigger de-bounce timing

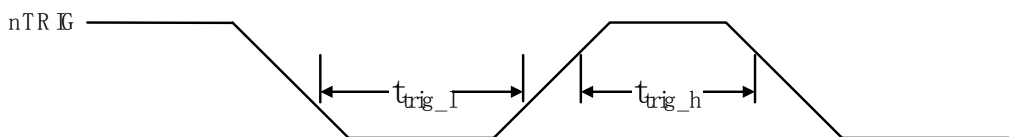

Figure 2-8 Hardware trigger timing

2-7 Operation of engine

The following cases demonstrate how a host operates an engine quickly and easily.

2-7-1 Example 1: Request revision

Case1: Request revision after awakening engine from Sleep Power state

- ① Host sends a <NUL> character (0x00).
- ② After 25 ms, Host sends a REQUEST_REVISION command (0x16, 0x4D, 0x0D, 0x25, 0x25, 0x25, 0x56, 0x45, 0x52, 0x2E).
- ③ After receiving the command, engine responds with firmware version.

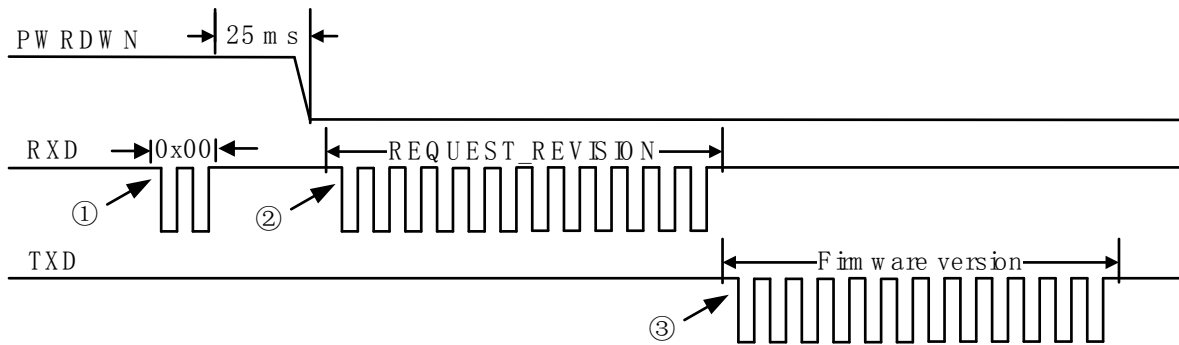

Case 2: Request revision after activating engine from Awake Power state

- ① Host sends a REQUEST_REVISION command (0x16, 0x4D, 0x0D, 0x25, 0x25, 0x25, 0x56, 0x45, 0x52, 0x2E).
- ② After receiving the command, engine responds with firmware version.

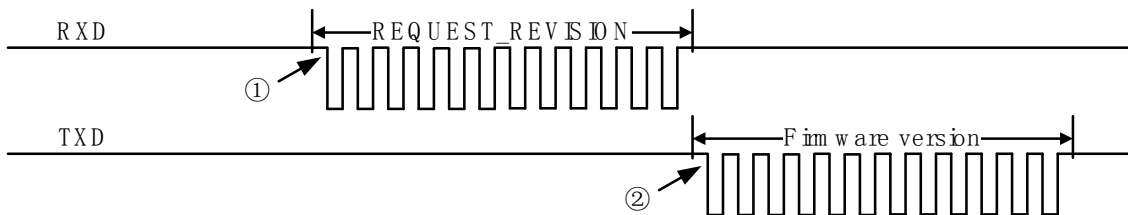

2-7-2 Example 2: Decode by pulling down pin TRIG

Case 1: Decode by pulling down pin TRIG after awakening engine from Sleep Power state

- ① Host pulls down pin TRIG.
- ② After 25 ms, then the engine turns on LED illumination and starts to decode. The LED illumination will be turned off if either Standby duration expires or engine succeeds in decoding.

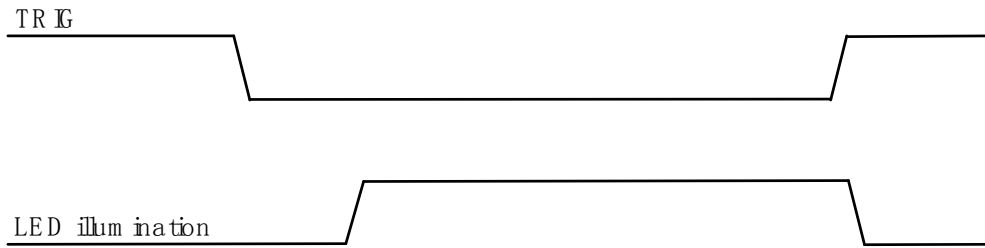

Case 2: Decode by pulling down pin TRIG after awakening engine from Awake Power state

- ① Host pulls down pin TRIG.
- ② Then engine turns on LED illumination and starts decode. The LED illumination will be turned off if either Standby duration expires or engine succeeds in decoding.

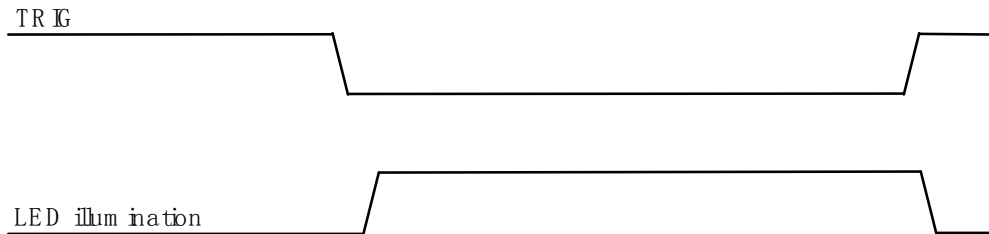

2-7-3 Example 3: Decode by commands

Case1: Decode after awakening engine from Sleep Power state

- ① Host sends a <NUL> character (0x00).
- ② After 25 ms, Host sends a command (0x16, 0x4D, 0x0D, 0x30, 0x34, 0x30, 0x31, 0x44, 0x30, 0x35, 0x2E) to set Scan mode to Host.
- ③ Then engine responds with received command and a <ACK> character (0x06), and then change Scan mode to Host.
- ④ After receiving the <ACK> character, Host sends a START_DECODE command (0x16, 0x54, 0x0D).
- ⑤ Then engine turns on LED illumination and decode. The LED illumination will be turned off if either Standby duration expires or engine succeeds in decoding. A STOP_DECODE command (0x16, 0x55, 0x0D) can end decode process.

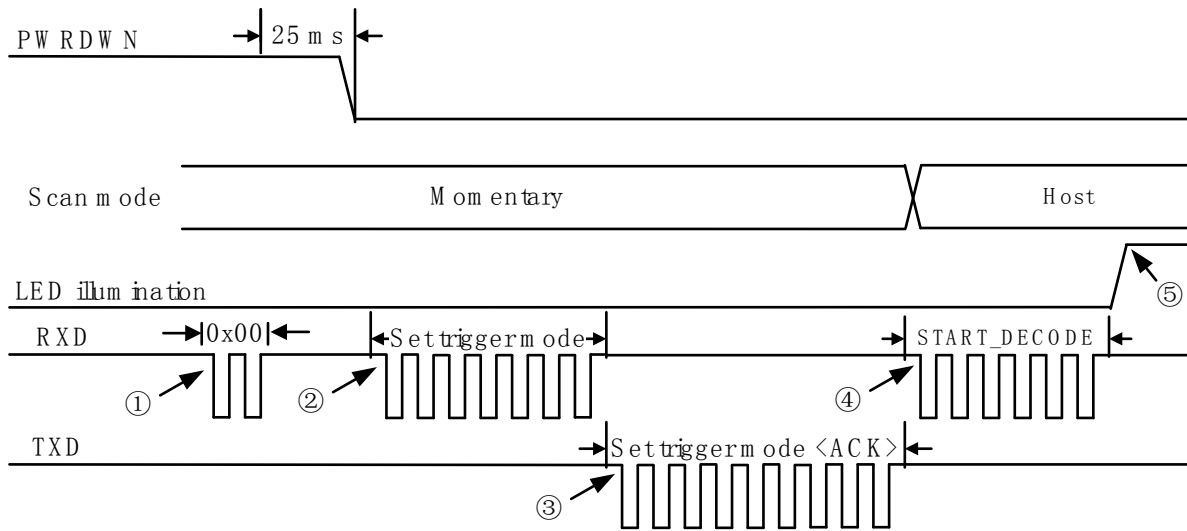

Case 2: Decode after awakening engine from Awake Power state

- ① Host sends a command (0x16, 0x4D, 0x0D, 0x30, 0x34, 0x30, 0x31, 0x44, 0x30, 0x35, 0x2E) to set Scan mode to Host.
- ② Then engine responds with received command and a <ACK> character (0x06), and then change Scan mode to Host.
- ③ After receiving the <ACK> character, Host sends a START_DECODE command (0x16, 0x54, 0x0D).
- ④ Then engine turns on LED illumination and decode. The LED illumination will be turned off if either Standby duration expires or engine succeeds in decoding. A STOP_DECODE command (0x16, 0x55, 0x0D) can end decode process.

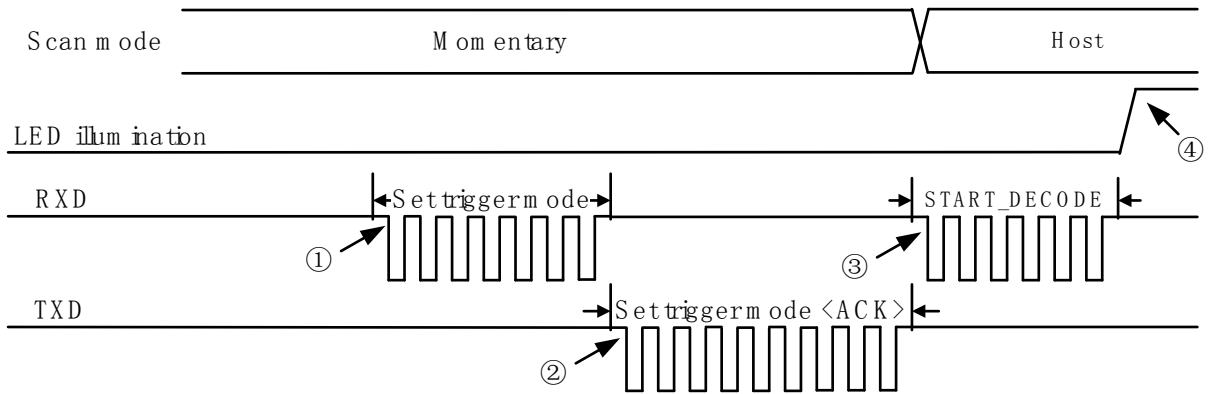

3 Parameter Menus

3-1 Introduction

This section describes the programmable parameters, to change the parameter values:

- ✚ Refer to [3-2 Example 1: Single-parameter setting by scanning 1D barcodes](#) and [3-3 Example 2: Multiple-parameter setting by scanning a QR code barcode](#), scan the appropriate barcodes included in this section, the new values replace the existing values.
- ✚ The factory default settings or customer default settings can be recalled by scanning appropriate barcodes, refer to [9 Return default parameters & firmware version](#).
- ✚ Instructions of programming and querying the engine by sending parameters refer to [4-1 Programming command syntax](#).

3-2 Example 1: Single-parameter setting by scanning 1D barcodes

Important notes: Throughout the programming barcode menus, the factory default settings are indicated with asterisks (*).

Two programming modes have been provided as bellows:

① Single-scan setting

Scan the appropriate **Single-scan setting** (e.g. **%0101D00%**) according to the user's demand.

Example: To set **Flow control** to be XON/XOFF.

Steps: Scan the following barcode.



② Multiple-scan setting

Step 1. Scan the **Option barcode** (e.g. **%0101M%**) according to the user's demand.

Step 2. To the right of the option barcode, the necessary alphanumeric inputs are listed. Scan two alphanumeric entries from **0** to **9** or **A** to **F**, refer to [10 Configuration alphanumeric entry barcode](#).

Step 3. Repeat Step 2, if more user parameters input are required.

Step 4. Scan the **%END%** barcode, listed on the lower left hand corner of each parameter setting part.

Example: To set **Flow control** to be XON/XOFF.

Steps: Scan the following barcodes in order.

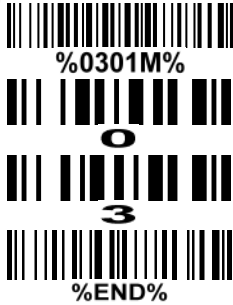

3-3 Example 2: Multiple-parameter setting by scanning a QR code barcode

User can customize a QR code barcode to set multiple parameters. The engine can set multiple parameters by scanning this single QR code barcode.

1. The data format of the QR code barcode is as following.

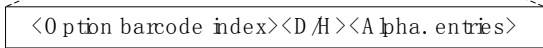
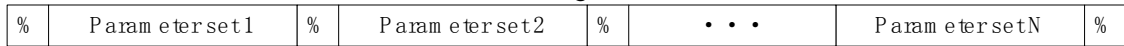

Note that:

- <Option barcode index> means the corresponding 4 digits of Option barcode.
- <D/H> means “D” or “H” character. “D” means that the type of alphanumeric entry is decimal; and “H” means that the type of alphanumeric entry is hexadecimal.
- <Alpha. entries> is a character string with various length of 2, 4, or other values.

Example: Set 0401->03 (decimal); 8002->0D0A (hexadecimal); 8202->01 (decimal). The customized QR code barcode contents and symbol are as following.

`%0401D03%8002H0D0A%8202D01%`



2. Notes of making QR code barcode

The model is chosen as M2. Other requirements, e.g. ECC level, Start mode, etc, are not specified.

3. Other notes

- The contents of a QR code barcode can include several same <Option barcode index> associated with same or different <Alpha. entries>. In the case of with different <Alpha. entries>, the latest <Alpha. entries> is the valid one.
- If any one of the parameter settings is invalid, the total setting is failed. The invalid setting can be caused by one of the following problems: invalid <Option barcode index>, invalid type of <D/H>, invalid type, length or value range of <Alpha. entries>, etc.

3-4 RS-232 interface

Flow control:

None - The communication only uses TXD and RXD signals without any hardware or software handshaking protocol.

RTS/CTS – If the engine wants to send the barcode data to the host, it will assert the RTS signal first, and then waits for the CTS signal from the host to perform normal data communication. If CTS is not asserted in Response delay, the engine will issue an error indication.























Two-direction flow control - The engine asserts the RTS signal when it is OK for the host to transmit. The host asserts CTS when it is OK for the device to transmit.













XON/XOFF – An <XOFF> character (0x13) turns the engine's transmission off until the engine receives an <XON> character (0x11).

ACK/NAK – After transmitting data, the engine expects either an <ACK> character (acknowledge) or <NAK> character response from the host. When a <NAK> character is received, the engine transmits the same data again and waits for either an <ACK> character or <NAK> character. After three unsuccessful attempts to send data when <NAK> characters are received the engine issues an error indication and discards the data.

Inter-character delay: This delay is inserted after each data character transmitted.

Response delay: This delay is used for serial communication of the engine when it waits for a handshaking acknowledgment from the host.

Multiple-scan setting			Single-scan setting
Option barcode	Option	Alpha. entry	
Flow control  %0301M%	None	00*	 %0301D00% *
	RTS/CTS	01	 %0301D01%
	Two-direction flow control	02	 %0301D02%
	XON/XOFF	03	 %0301D03%
	ACK/NAK	04	 %0301D04%
Inter-character delay  %0302M%	0 ms	00*	 %0302D00% *
	5 ms	01	 %0302D01%
	10 ms	02	 %0302D02%
	20 ms	03	 %0302D03%
	40 ms	04	 %0302D04%
	80 ms	05	 %0302D05%
Response delay  %0304M%	00-99 (100 ms)	00-99	
		00*	 %0304D00% *
Baudrate  %0305M%	300	00	 %0305D00%
	600	01	 %0305D01%
	1200	02	 %0305D02%
	2400	03	 %0305D03%
	4800	04	 %0305D04%
	9600	05*	 %0305D05% *
	19200	06	 %0305D06%

Multiple-scan setting			Single-scan setting
Option barcode	Option	Alpha. entry	
	38400	07	 %0305D07%
	57600	08	 %0305D08%
	115200	09	 %0305D09%
Parity bit  %0306M%	None	00*	 %0306D00% *
	Odd	01	 %0306D01%
	Even	02	 %0306D02%
Data bit  %0307M%	8 bits	00*	 %0307D00% *
	7 bits	01	 %0307D01%
Stop bit  %0308M%	1 bit	00*	 %0308D00% *
	2 bits	01	 %0308D01%

%END%

3-5 USB interface

USB device type:

HID keyboard – By setting, the embedded engine is used as a USB HID keyboard emulation device.

USB virtual COM – By setting, the embedded engine emulates a regular RS-232-based COM port. If a Microsoft Windows PC is connected to the embedded engine, a driver is required to install on the connected PC. The driver will use the next available COM Port number. The driver and the installation guide can be found in the associated CD and on the manufacturer's website. A Windows-based software COM_Text is recommended to display the barcode data in text format. COM_Text emulates some kind of serial-key typing.

Simple COM Port Emulation - Please contact the manufacturer for the instruction.

Notes:

1) When change USB Device Type, the embedded engine automatically restarts.

2) USB Device Type will be changed to USB virtual COM if Scan Mode is set as Host. Besides, the change of USB Device Type from the USB virtual COM to others is forbidden when Scan Mode is Host.

Keyboard layout: The embedded engine supports different national keyboard layouts.

Inter-character delay: This delay is inserted after each data character transmitted. By selecting, the user can change the output speed of the embedded engine to match the speed of the host USB communication port.





















Numeric key:









Alphabetic key - The embedded engine will output code result as alphabetic key.

Numeric key - The embedded engine will output code result as pressing numeric keypad ('0', '1', '2', '3', '4', '5', '6', '7', '8', '9', '.', '+', '-', '/', '*' only).

Alt+ keypad - The embedded engine will output code result as pressing Alt+ numeric key (on keypad).

Note that the Num Lock control key must be ON. This setting can be specially adapted for use with different national keyboard layout.

Multiple-scan setting			Single-scan setting
Option bar code	Option	Alpha. entry	
USB device type  %0901M%	HID keyboard	00*	 %0901D00% *
	HID keyboard for Apple Mac	01	 %0901D01%
	USB virtual COM	02	 %0901D02%
	Simple COM Port Emulation	03	 %0901D03%
Keyboard layout  %0902M%	USA	00*	 %0902D00% *
	Turkish F	01	 %0902D01%
	Turkish Q	02	 %0902D02%
	French	03	 %0902D03%
	Italian	04	 %0902D04%
	Spanish	05	 %0902D05%
	Slovak	06	 %0902D06%
	Denmark	07	 %0902D07%
	Japanese	08	 %0902D08%
	German	09	 %0902D09%
	Belgian	10	 %0902D10%
Russian	11	 %0902D11%	
Inter-character delay  %0903M%	0 ms	00	 %0903D00%
	5 ms	01*	 %0903D01% *

Multiple-scan setting			Single-scan setting
Option bar code	Option	Alpha. entry	
	10 ms	02	 %0903D02%
	20 ms	03	 %0903D03%
	40 ms	04	 %0903D04%
	60 ms	05	 %0903D05%
Numeric key  %0904M%	Alphabetic key	00*	 %0904D00% *
	Numeric keypad	01	 %0904D01%
	Alt + keypad	02	 %0904D02%

 %END%

3-6 Scan mode & some global settings

Scan mode:

Good-read off – The trigger (Pin - 12 TRIG) must be pulled down once to activate scanning. The engine stops scanning when there is a successful reading or no code is decoded after the **Scan standby duration** elapsed.

Momentary – Pin TRIG acts as a switch. Pull down pin TRIG to activate scanning and pull up the trigger to stop scanning. The light source of the engine stops scanning when there is a successful reading or no code is decoded after the **Scan standby duration** elapsed.

Alternate – Pin TRIG acts as a toggle switch. Pull pin TRIG to activate or stop scanning.

Continuous – The engine always keeps scanning, and it does not matter when pin TRIG is pulled down or duration is elapsed.

Timeout off- Pin TRIG must be pulled down once to activate scanning. The engine stops scanning when there is a successful reading.

Host – A START_DECODE command issues the triggering signal. In this mode, the engine interprets an actual trigger pull as a Good-read off triggering option.

Auto-detection- Good-read off – By setting Enable, the engine will start scanning if any nearby object has been detected. The engine will stop scanning when there is a successful reading or no code is decoded after the **Stand-by duration** elapsed. Once the engine stops scanning, the present object must be removed to enable **Auto-detection**.

Auto-detection- Good-read on – By setting Enable, the engine will start scanning if any nearby object has been detected. The engine stops scanning when no code is successful decoded after the **Stand-by duration** elapsed. Once the engine stops scanning, the present object must be removed to enable **Auto-detection**.

Auto-detection sensitivity: The value of sensitivity, range from 5% to 50%, the smaller the value, the higher the sensitivity, and the engine more likely to be triggered.

Same barcode delay time for 1D symbol: If a 1D barcode has been scanned and output once successfully, the image platform must output the same barcode data beyond delay time. When this feature is set to be "0xFF", then the delay time is indefinite.

Same barcode delay time for 2D symbol: If a 2D barcode has been scanned and output once successfully, the image platform must output the same barcode data beyond delay time. When this feature is set to be "0xFF", then the delay time is indefinite.

Double confirm: If it is enabled, the image platform will require a several times of same-decoded-data to confirm a valid reading.

Global Max./Min. code length for 1D symbol: These two lengths are defined as the valid range of decoded 1D barcode data length. Make sure that the minimum length setting is no greater than the maximum length setting, or otherwise the labels of the symbol will not be readable. In particular, the same value can be set for both minimum and maximum reading length to force the fixed length barcode decoded.

Notes:

1. Please set the max./min. length for individual barcode in later sections, if special demand is requested.

2. The number of check digits is included in max./min. code length.

3. These two settings have no effect on the symbols with fixed-length, e.g. UPC-A, UPC-E, EAN-13, EAN-8 and China Post.

Global G1-G6 string selection: The image platform offer one or two string group for all symbols. By setting one or two digits to indicate which string group you want to apply. You may refer to [3-40 G1-G6 & C1-C2 & FN1 substitution string setting](#) and [3-41 G1-G4 string position & Code ID position](#).

Example: Group 1 → set 01 or 10. Group 2 and 4 → set 24 or 42.

All valid settings include 00, 01, 02, 03, 04, 05, 06, 10, 11, 12, 13, 14, 15, 16, 20, 21, 22, 23, 24, 25, 26, 30, 31, 32, 33, 34, 35, 36, 40, 41, 42, 43, 44, 45, 46, 50, 51, 52, 53, 54, 55, 56, 60, 61, 62, 63, 64, 65 and 66.

Element amendment: If it is enabled, the image platform can read the barcode comprised with bars and spaces in different scale.

Character output restraint:

Printable character only- If this option is selected, the image platform will output the printable characters only, i.e. in ASCII from 20H to 7EH.

Alphanumeric character only- If this option is selected, the image platform will output the alphanumeric characters only, i.e. "A"-“Z”, "a"-“z”, "0"-“9”.

Decoder optimization: If it is enabled, the image platform will optimize the decoder with error correction.

This function is not effective for all types of barcode.

























Data output delay in continue-scan mode: If it is enabled, in the continue-scan mode, the image platform can store the data while continue-scanning. The image platform will output the data after the predefined delay elapsed. The maximum storage of data is 1000 characters. If this parameter is set to be "00", the image platform will not store data. And if the parameter is set to be "FF", the image platform will output data after stopping scanning.



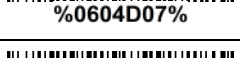
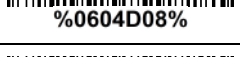



















Character encoding system: A character encoding system consists of a code that pairs each character from a given repertoire. Common examples include Morse code, the Baudot code, the ASCII and Unicode. If the data received does not display with the proper characters (domestic language, e.g. Chinese), it maybe because the barcode being scanned was created using a character encoding system that is different from the one the host program is expecting. Try alternate options to find the proper one.





























Complete data output before next decode attempt: This setting is active only when USB device type is set as "HID keyboard" or "HID keyboard for Apple Mac". If it is enabled, the engine will not start next decode attempt until previous data output is completed.









Sleep mode: If it is enabled, the engine will go to sleep when no code is successful decoded after the Sleep mode delay elapsed.

Sleep mode delay: When no code is successful decoded beyond this time, the engine will go to sleep.

Multiple-scan setting			Single-scan setting
Option barcode	Option	Alpha. entry	
Scan mode  %0401M%	Good-read off	00	 %0401D00%
	Momentary	01*	 %0401D01% *
	Alternate continue	02	 %0401D02%
	Continue	03	 %0401D03%
	Time-out off	04	 %0401D04%
	Host	05	 %0401D05%
	Auto-detection- Good-read on	06	 %0401D06%
	Auto-detection- Good-read off	07	 %0401D07%
Auto-detection sensitivity  %0604M%	5%*	00*	 %0604D00% *
	10%	01	 %0604D01%
	15%	02	 %0604D02%
	20%	03	 %0604D03%
	25%	04	 %0604D04%
	30%	05	 %0604D05%
	35%	06	 %0604D06%
	40%	07	 %0604D07%
	45%	08	 %0604D08%
	50%	09	 %0604D09%
Standby duration  %0402M%	4 seconds	00*	 %0402D00% *
	8 seconds	01	 %0402D01%
	16 seconds	02	 %0402D02%
	24 seconds	03	 %0402D03%

Multiple-scan setting			Single-scan setting
Option barcode	Option	Alpha. entry	
	30 seconds	04	 %0402D04%
	1 minute	05	 %0402D05%
	1.5 minutes	06	 %0402D06%
	2 minutes	07	 %0402D07%
	5 minutes	08	 %0402D08%
	7 minutes	09	 %0402D09%
	10 minutes	10	 %0402D10%
	15 minutes	11	 %0402D11%
	20 minutes	12	 %0402D12%
	30 minutes	13	 %0402D13%
	45 minutes	14	 %0402D14%
	1 hour	15	 %0402D15%
Same barcode delay time for 1D symbol  %0403M%	00-FF ₁₆ (50 ms)	00-FF ₁₆	
		00	 %0403H00%
		08*	 %0403H08% *
Same barcode delay time for 2D symbol  %0415M%	00-FF ₁₆ (50 ms)	00-FF ₁₆	
		00	 %0415H00%
		08*	 %0415H08% *
Double confirm  %0404M%	00-09 (00: no)	00-09	
		00*	 %0404D00% *
Global max. code length for 1D symbol  %0405M%	04-99	04-99	
		99*	 %0405D99% *

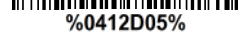
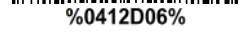
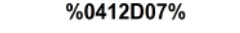
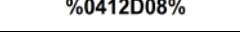
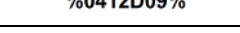
Multiple-scan setting			Single-scan setting
Option barcode	Option	Alpha. entry	
Global min. code length for 1D symbol  %0406M%	01-99	01-99	
		04*	 %0406D04% *
Global G1-G6 string selection  %0407M%	00-66	00-66	
		00*	 %0407D00% *
Element amendment  %0408M%	Disable	00	 %0408D00%
	Enable	01*	 %0408D01% *
Character output restraint  %0409M%	None	00*	 %0409D00% *
	Printable character only	01	 %0409D01%
	Alphanumeric character only	02	 %0409D02%
Decoder optimization  %0410M%	Disable	00	 %0410D00%
	Enable	01*	 %0410D01% *
Data output delay in continue-scan mode  %0411M%	00-99 (100 ms) FF (Never)	00-FF ₁₆	
		00*	 %0411H00% *
Character encoding system  %0413M%	ASCII	00*	 %0413D00% *
	UTF-8	01	 %0413D01%
	Windows-1251	02	 %0413D02%
	GBK	03	 %0413D03%
	Big 5	04	 %0413D04%
Complete data output before next decode attempt  %0414M%	Disable	00*	 %0414D00%
	Enable	01	 %0414D01%
Sleep mode  %0416M%	Disable	00	 %0416D00%
	Enable	01*	 %0416D01% *

Multiple-scan setting			Single-scan setting
Option barcode	Option	Alpha. entry	
Sleep mode delay  %0412M%	1 second	00*	 %0412D00% *
	5 seconds	01	 %0412D01%
	10 seconds	02	 %0412D02%
	30 seconds	03	 %0412D03%
	60 seconds (1 minute)	04	 %0412D04%
	300 seconds (5 minutes)	05	 %0412D05%
	600 seconds (10 minutes)	06	 %0412D06%
	1800 seconds (30 minutes)	07	 %0412D07%
	3600 seconds (1 hour)	08	 %0412D08%
	10800 seconds (3 hours)	09	 %0412D09%
 %END%			

3-7 Indication

Power on alert: After power-on the engine will generate an alert signal to indicate a successful self-test.



















LED indication: After each successful reading, the LED above the engine will light up to indicate a good barcode reading.

Beeper indication: After each successful reading, the engine will beep to indicate a good barcode reading, and its beep tone duration is adjustable.

Beep tone duration: This parameter can be adjusted for a good reading upon favorite usage.

Volume of beeper: This parameter can be adjusted for different level of the volume of the beeper.

Vibrator indication: After each successful reading, the engine will vibrate to indicate a good barcode reading.

Multiple-scan setting			Single-scan setting
Option barcode	Option	Alpha. entry	
Power on alert  %0501M%	Disable	00	 %0501D00%
	Enable	01*	 %0501D01% *
LED indication  %0502M%	Disable	00	 %0502D00%
	Enable	01*	 %0502D01% *
Beeper indication  %0503M%	Disable	00	 %0503D00%
	Enable	01*	 %0503D01% *
Beep tone duration  %0504M%	01-09 (10 ms)	01-09	
		05*	 %0504D05% *
Volume of beeper  %0505M%	Low	00	 %0505D00%
	Middle	01	 %0505D01%
	High	02*	 %0505D02% *
Vibrator indication  %0507M%	Disable	00	 %0507D00%
	Enable	01*	 %0507D01% *

 %END%

3-8 Decode illumination mode and decode aiming pattern

Decode illumination mode: Enable illumination causes the engine to turn on the illumination to aid decoding. Disable illumination to turn off illumination for the engine during decoding. Better quality images could be obtained with illumination support. The effectiveness of the illumination decreases as the distance to the target increases.

Decode aiming pattern: When this option is enabled, the engine will project the aiming pattern during the code capture.

Level of decode illumination: This parameter can be adjusted for different level of decode illumination.





















Illumination mode of Auto-detection:

Always off- Illumination LED will be always turned off.

Enable illumination in low light conditions- In low light conditions, the engine will turn on illumination LED automatically to ensure normal work. While in other light conditions, the illumination LED will be turned off automatically.

Always on- Illumination LED will be always turned on (Default).

Note: This function is only valid in Auto-detection mode.

Multiple-scan setting			Single-scan setting
Option barcode	Option	Alpha. entry	
Decode illumination mode  %9001M%	Always Off	00	 %9001D00%
	Always On	01	 %9001D01%
	Flashing	02*	 %9001D02% *
	On when reading	03	 %9001D03%
Decode aiming pattern  %9002M%	Always off	00	 %9002D00%
	Always on	01	 %9002D01%
	On before reading	02	 %9002D02%
	On when reading	03*	 %9002D03% *
Level of decode illumination  %9003M%	Disable decode illumination	00	 %9003D00%
	Low	01	 %9003D01%
	Middle	02*	 %9003D02% *
	High	03	 %9003D03%
Illumination mode of Auto-detection  %0605M%	Always off	00	 %0605D00%
	Enable illumination in low light conditions	01	 %0605D01%
	Always on	02*	 %0605D02% *
 %END%			

3-9 Single type of barcode, Multi-symbols, and Vertical centering read

1D symbols read: A global setting of 1D symbols readability.

2D symbols read: A global setting of 2D symbols readability.

Multi-symbols read: By setting Enable, the engine allows to read multiple symbols in one image. By setting Disable, the engine will only read the symbol closest to the center area in the image.

Vertical centering read: By setting enable, the engine reads only the barcode centered by the aimer in vertical direction. However, the engine will read either one of two barcodes which are positioned horizontally. See example below.

Mobile screen read: By setting enable, the engine can read barcodes on a mobile screen better. However, this will slow the reading speed of normal barcodes a little bit.

Multiple-scan setting			Single-scan setting
Option barcode	Option	Alpha. entry	
1D symbols read  %1005M%	Follow respective 1D symbol setting	00*	 %1005D00% *
	All 1D Disable	01	 %1005D01%
2D symbols read  %1001M%	Follow respective 2D symbol setting	00*	 %1001D00% *
	All 2D Disable	01	 %1001D01%
	All 2D Enable	02	 %1001D02%
	Only PDF417 Enable	03	 %1001D03%
	Only QR code Enable	04	 %1001D04%
	Only Data Matrix Enable	05	 %1001D05%
	Only MaxiCode Enable	06	 %1001D06%
	Only Aztec Code Enable	07	 %1001D07%
Only Han Xin Code Enable	08	 %1001D08%	
Multi-symbols read  %1003M%	Disable	00*	 %1003D00% *
	Enable	01	 %1003D01%
Vertical centering read  %1004M%	Disable	00*	 %1004D00% *
	Enable	01	 %1004D01%
Mobile screen read  %1007M%	Disable	00	 %1007D00%
	Enable	01*	 %1007D01% *
 %END%			

Note: The instruction of calibrating the aimer in vertical centering direction.

1. Scan the barcode ("%initD00%") on this page. The engine will give three musical short beeps to indicate entering calibration mode.
2. Press the trigger of the engine while maintaining the distance of about 15cm between the scan window of the engine and this paper. After a few seconds, the engine will give three short beeps to indicate a successful calibration, or a long beep to indicate a failed calibration.
3. If the calibration is failed in step 2, please repeat the steps 1-2. If it is not succeed after a multiple times of calibration, please contact your local dealer or the manufacturer for further instruction.



3-10 UPC-A

Read:

Format

System character	Data digits (10 digits)	Check digit
------------------	-------------------------	-------------

Check digit verification: The check digit is optional.

Check digit trans.: By setting Enable, check digit will be transmitted.

Code ID setting: Code ID is a one-two-character string used to represent the symbol upon a succeeding reading. If you want application to transmit Code ID, you must set **Code ID transmission** to be enabled.

Refer to [3-42 String transmission](#).

Insertion group selection: Refer to Global insertion group selection of [3-6 Scan mode & some global settings](#).

Supplement digits: The Supplement digits barcode is the supplemental 2 of 5 characters.

Format

System character	Data digits (10 digits)	Check digit	Supplement digits 2 of 5
------------------	-------------------------	-------------	--------------------------

Truncation/Expansion:

Truncate leading zeros - The leading "0" digits of UPC-A data characters can be truncated when the feature is enabled.

Example: Barcode "001234567895",

Output: "1234567895".

Expand to EAN-13 - It extends to 13-digits with a "0" leading digit when the feature is enabled.

Example: Barcode "001234567895",

Output: "0001234567895".

Truncate system character - The system character of UPC-A data can be truncated when the feature is enabled.

























Example: Barcode "001234567895",

Output: "01234567895".

Add country code - The country code ("0" for USA) can be added when the feature is enabled.

Example: Barcode "001234567895",

Output: "0001234567895".

Multiple-scan setting			Single-scan setting
Option barcode	Option	Alpha. entry	
Read  %1101M%	Disable	00	 %1101D00%
	Enable	01*	 %1101D01% *
Check digit verification  %1102M%	Disable	00	 %1102D00%
	Enable	01*	 %1102D01% *
Check digit trans.  %1103M%	Disable	00	 %1103D00%
	Enable	01*	 %1103D01% *
Code ID setting  %1104M%	00-FF ₁₆ (ASCII)	00-FF ₁₆	
		<A>*	 %1104H41% *
Insert group selection  %1105M%	00-66	00-66	
		00*	 %1105D00% *
Supplement digits  %1106M%	None	00*	 %1106D00% *
	2 digits	01	 %1106D01%
	5 digits	02	 %1106D02%
	2 or 5 digits	03	 %1106D03%
Truncation/Expansion  %1107M%	None	00*	 %1107D00% *
	Truncate leading zeros	01	 %1107D01%
	Expand to EAN-13	02	 %1107D02%
	Truncate system character	03	 %1107D03%
	Add country code	04	 %1107D04%

%END%

3-11 UPC-E

Read:

Format

System character "0"	Data digits (6 digits)	Check digit
----------------------	------------------------	-------------

Check digit verification: The check digit is optional.

Check digit trans.: By setting Enable, check digit will be transmitted.

Code ID setting: Refer to [Code ID setting](#) of [3-10 UPC-A](#).

Insertion group selection: Refer to [Insertion group selection](#) of [3-10 UPC-A](#).

Supplement digits:

Format

System character "0"	Data digits (6 digits)	Check digit	Supplement digits 2 of 5
----------------------	------------------------	-------------	--------------------------

Truncation/Expansion:

Truncate leading zeros - The leading "0" digits of UPC-E data characters can be truncated when the feature is enabled.

Example: Barcode "00123457",

Output: "123457".

Expand to EAN-13 - It extends to 13-digits with a "0" leading digit when the feature is enabled.

Example: Barcode "00123457",

Output: "0001234000057".

Expand to UPC-A - It extends to 12-digits when the feature is set to be enabled.

Example: Barcode "00123457",

Output: "001234000057".

Truncate system character - The system character "0" of UPC-E data can be truncated when the feature is enabled.

























Example: Barcode "00123457",

Output: "0123457".

Add country code - The country code ("0" for USA) can be added when the feature is enabled.

Example: Barcode "00123457",

Output: "000123457".

Multiple-scan setting			Single-scan setting
Option barcode	Option	Alpha. entry	
Read  %1201M%	Disable	00	 %1201D00%
	Enable	01*	 %1201D01% *
Check digit verification  %1202M%	Disable	00	 %1202D00%
	Enable	01*	 %1202D01% *
Check digit trans.  %1203M%	Disable	00	 %1203D00%
	Enable	01*	 %1203D01% *
Code ID setting  %1204M%	00-FF ₁₆ (ASCII)	00-FF ₁₆	
		<D>*	 %1204H44% *
Insert group selection  %1205M%	00-66	00-66	
		00*	 %1205D00% *
Supplement digits  %1206M%	None	00*	 %1206D00% *
	2 digits	01	 %1206D01%
	5 digits	02	 %1206D02%
	2 or 5 digits	03	 %1206D03%
Truncation/Expansion  %1207M%	None	00*	 %1207D00% *
	Truncate leading zeros	01	 %1207D01%
	Expand to EAN-13	02	 %1207D02%
	Expand to UPC-A	03	 %1207D03%
	Truncate system character	04	 %1207D04%
	Add country code	05	 %1207D05%

%END%

3-12 UPC-E1

Read:

Format

System character "1"	Data digits (6 digits)	Check digit
----------------------	------------------------	-------------

Check digit verification: The check digit is optional.

Check digit trans.: By setting Enable, check digit will be transmitted.

Code ID setting: Refer to [Code ID setting](#) of 3-10 UPC-A.

Insertion group selection: Refer to [Insertion group selection](#) of 3-10 UPC-A.

Supplement digits:

Format

System character "1"	Data digits (6 digits)	Check digit	Supplement digits 2 of 5
----------------------	------------------------	-------------	--------------------------

Truncation/Expansion:

Expand to EAN -13 - It extends to 13-digits with "0" digits when the feature is enabled.

Example: Barcode "10012341",

Output: "0100120000031".

Expand to UPC-A - It extends to 12-digits when the feature is set to be enabled.

Example: Barcode "10012341",

Output: "100120000031".

Truncate system character - The system character "1" of UPC-E1 data can be truncated when the feature is enabled.

Example: Barcode "10012341",

Output: "0012341".

Add country code - The country code ("0" for USA) can be added when the feature is enabled.

Example: Barcode "10012341",

Output: "010012341".

Multiple-scan setting			Single-scan setting
Option barcode	Option	Alpha. entry	
Read  %3401M%	Disable	00*	 %3401D00% *
	Enable	01	 %3401D01%
Check digit verification  %3402M%	Disable	00	 %3402D00%
	Enable	01*	 %3402D01% *
Check digit trans.  %3403M%	Disable	00	 %3403D00%
	Enable	01*	 %3403D01% *
Code ID setting  %3404M%	00-FF ₁₆ (ASCII)	00-FF ₁₆	
		<D>*	 %3404H44% *
Insert group selection  %3405M%	00-66	00-66	
		00*	 %3405D00% *
Supplement digits  %3406M%	None	00*	 %3406D00% *
	2 digits	01	 %3406D01%
	5 digits	02	 %3406D02%
	2 or 5 digits	03	 %3406D03%
Truncation/Expansion  %3407M%	None	00*	 %3407D00% *
	Expand to EAN-13	02	 %3407D02%
	Expand to UPC-A	03	 %3407D03%
	Truncate system character	04	 %3407D04%
	Add country code	05	 %3407D05%

%END%

3-13 EAN-13

Read:

Format

Data digits (12 digits)	Check digit
-------------------------	-------------

Check digit verification: The check digit is optional.

Check digit trans.: By setting **Enable**, check digit will be transmitted.

Code ID setting: Refer to

Code ID setting

 of [3-10 UPC-A](#).

Insertion group selection: Refer to

Insertion group selection

 of [3-10 UPC-A](#).

Supplement digits:

Format

Data digits (12 digits)	Check digit	Supplement digits 2 of 5
-------------------------	-------------	--------------------------

ISBN/ISSN conversion: The ISBN (international Standard Book Number, or Bookland EAN) and ISSN (International Standard Serial Number) are two kinds of barcode for books and magazines. The ISBN is 10 digits with leading "978" and the ISSN is 8 digits with leading "977" of the EAN-13.

Example:























Barcode "9780194315104", Output: "019431510X".

Barcode "9771005180004", Output: "10051805".

ISBN/ISSN code ID setting: Refer to

Code ID setting

 of [3-10 UPC-A](#).

Multiple-scan setting			Single-scan setting
Option barcode	Option	Alpha. entry	
Read  %1301M%	Disable	00	 %1301D00%
	Enable	01*	 %1301D01% *
Check digit verification  %1302M%	Disable	00	 %1302D00%
	Enable	01*	 %1302D01% *
Check digit trans.  %1303M%	Disable	00	 %1303D00%
	Enable	01*	 %1303D01% *
Code ID setting  %1304M%	00-FF ₁₆ (ASCII)	00-FF ₁₆	
		<D>*	 %1304H41% *
Insert group selection  %1305M%	00-66	00-66	
		00*	 %1305D00% *
Supplement digits  %1306M%	None	00*	 %1306D00% *
	2 digits	01	 %1306D01%
	5 digits	02	 %1306D02%
	2 or 5 digits	03	 %1306D03%
ISBN/ISSN conversion  %1307M%	Disable	00*	 %1307D00% *
	Enable	01	 %1307D01%
ISBN/ISSN code ID setting  %1309M%	00-FF ₁₆ (ASCII)	00-FF ₁₆	
		*	 %1309H42% *

%END%

3-14 EAN-8

Read:

Format

Data digits (7 digits)	Check digit
------------------------	-------------

Check digit verification: The check digit is optional.

Check digit trans.: By setting Enable, check digit will be transmitted.

Code ID setting: Refer to [Code ID setting](#) of [3-10 UPC-A](#).

Insertion group selection: Refer to [Insertion group selection](#) of [3-10 UPC-A](#).

Supplement digits:

Format

Data digits (8 digits)	Check digit	Supplement digits 2 of 5
------------------------	-------------	--------------------------

Truncation/Expansion: Refer to [Truncation/Expansion](#) of [3-10 UPC-A](#).

Multiple-scan setting			Single-scan setting
Option barcode	Option	Alpha. entry	
Read  %1401M%	Disable	00	 %1401D00%
	Enable	01*	 %1401D01% *
Check digit verification  %1402M%	Disable	00	 %1402D00%
	Enable	01*	 %1402D01% *
Check digit trans.  %1403M%	Disable	00	 %1403D00%
	Enable	01*	 %1403D01% *
Code ID setting  %1404M%	00-FF ₁₆ (ASCII)	00-FF ₁₆	
		<C>*	 %1404H43% *
Insert group selection  %1405M%	00-66	00-66	
		00*	 %1405D00% *
Supplement digits  %1406M%	None	00*	 %1406D00% *
	2 digits	01	 %1406D01%
	5 digits	02	 %1406D02%
	2 or 5 digits	03	 %1406D03%
Truncation/Expansion  %1407M%	None	00*	 %1407D00% *
	Truncate leading zero	01	 %1407D01%
	Expand to EAN-13	02	 %1407D02%

 %END%

3-15 Code 39 (Code 32, Trioptic Code 39)

Read:

Format

Start character (*)	Data digits (variable)	Check digit (optional)	End character (*)
---------------------	------------------------	------------------------	-------------------

Check digit verification: The check digit is optional and made as the sum module 43 of the numerical value of the data digits.

Check digit trans.: By setting Enable, check digit will be transmitted.

Max./Min. code length: Each symbol has own max./min. code length. If both setting of max./min. code length are "00", the setting of global max./min. code length is effective. The length is defined as to the actual barcode data length to be sent. Label with length exceeds these limits will be rejected. Make sure that the minimum length setting is no greater than the maximum length setting or otherwise all labels of the symbol will bet be readable. In particular, you can see the same value for both minimum and maximum reading length to force the fixed length barcode decoded.

Code ID setting: Refer to [Code ID setting](#) of [3-10 UPC-A](#).

Insertion group selection: Refer to [insertion group selection](#) of [3-10 UPC-A](#).

Start/End transmission: the start and end characters of Code 39 are "*". You can transmit all data digits including two "*".

"*" as data character: by setting Enable, "*" can be recognized as data character.

Convert Code 39 to Code 32: Code 32 is a variant of Code 39 used by the Italian pharmaceutical industry. Note that code 39 must be enabled in order for this parameter to function.

Format of Code 32

"A"(optional)	Data digits (8 digits)	Check digit
---------------	------------------------	-------------



























Code 32 Prefix "A" transmission: By setting Enable, the prefix character "A" can be added to all Code 32 barcodes.











Trioptic Code 39 read: Trioptic Code 39 is a variant of Code 39 used in the marking of magnetic tapes and computer cartridges. Trioptic Code 39 symbols always contain six characters.

Format

Start character(\$)	Data digits (8 digits)	End character(\$)
---------------------	------------------------	-------------------

Trioptic Code 39 Start/End transmission: The start and end characters of Trioptic Code 39 are "\$". All data digits including two "\$" can be transmitted.

Multiple-scan setting			Single-scan setting
Option barcode	Option	Alpha. entry	
Read  %1501M%	Disable	00	 %1501D00%
	Enable	01*	 %1501D01% *
Check digit verification  %1502M%	Disable	00	 %1502D00%
	Enable	01*	 %1502D01% *
Check digit trans.  %1503M%	Disable	00	 %1503D00%
	Enable	01*	 %1503D01% *
Max. code length  %1504M%	00-99	00-99	
		99*	 %1504D99% *
Min. code length  %1505M%	00-99	00-99	
		01*	 %1505D01% *
Code ID setting  %1506M%	00-FF ₁₆ (ASCII)	00-FF ₁₆	
		<M>*	 %1506H4D% *
Insert group selection  %1507M%	00-66	00-66	
		00*	 %1507D00% *
Format  %1508M%	Standard	00*	 %1508D00% *
	Full ASCII	01	 %1508D01%
Start/End transmission  %1509M%	Disable	00*	 %1509D00%
	Enable	01	 %1509D01% *
"*" as data character  %1510M%	Disable	00*	 %1510D00% *
	Enable	01	 %1510D01%

Multiple-scan setting			Single-scan setting
Option barcode	Option	Alpha. entry	
Convert Code 39 to Code 32  %1511M%	Disable	00*	 %1511D00% *
	Enable	01	 %1511D01%
Code 32 prefix "A" transmission  %1512M%	Disable	00*	 %1512D00% *
	Enable	01	 %1512D01%
Trioptic Code 39 read  %1513M%	Disable	00*	 %1513D00% *
	Enable	01	 %1513D01%
Trioptic Code 39 Start/End transmission  %1514M%	Disable	00*	 %1514D00% *
	Enable	01	 %1514D01%
 %END%			

3-16 Interleaved 2 of 5

Read:

Format

Data digits (variable)	Check digit (optional)
------------------------	------------------------

















Check digit verification: The check digit is made as the sum module 10 of the numerical value of the data digits. There are two optional check digit algorithms: the specified Uniform Symbol Specification (USS) and the Optical Product Code Council (OPCC).

Check digit trans.: By setting Enable, check digit will be transmitted.

Max./Min. code length: Refer to [Max./Min. code length](#) of [3-15 Code 39 \(Code 32, Trioptic Code 39\)](#).

Code ID setting: Refer to [Code ID setting](#) of [3-10 UPC-A](#).

Insertion group selection: Refer to [Insertion group selection](#) of [3-10 UPC-A](#).

Multiple-scan setting			Single-scan setting
Option barcode	Option	Alpha. entry	
Read  %1601M%	Disable	00	 %1601D00%
	Enable	01*	 %1601D01% *
Check digit verification  %1602M%	Disable	00*	 %1602D00% *
	USS	01	 %1602D01%
	OPCC	02	 %1602D02%
Check digit trans.  %1603M%	Disable	00*	 %1603D00% *
	Enable	01	 %1603D01%
Max. code length  %1604M%	00-99	00-99	
		99*	 %1604D99% *
Min. code length  %1605M%	00-99	00-99	
		06*	 %1605D06% *
Code ID setting  %1606M%	00-FF ₁₆ (ASCII)	00-FF ₁₆	
		<I>*	 %1606H49% *
Insert group selection  %1607M%	00-66	00-66	
		00*	 %1607D00% *

 %END%

3-17 Industrial 2 of 5











Read:
Format

Data digits (variable)

Max./Min. code length: Refer to Max./Min. code length of 3-15 Code 39 (Code 32, Trioptic Code 39).

Code ID setting: Refer to Code ID setting of 3-10 UPC-A.

Insertion group selection: Refer to Insertion group selection of 3-10 UPC-A.

Multiple-scan setting			Single-scan setting
Option barcode	Option	Alpha. entry	
Read  %1701M%	Disable	00*	 %1701D00% *
	Enable	01	 %1701D01%
Max. code length  %1702M%	00-99	00-99	
		00*	 %1702D99% *
Min. code length  %1703M%	00-99	00-99	
		04*	 %1703D04% *
Code ID setting  %1704M%	00-FF ₁₆ (ASCII)	00-FF ₁₆	
		<H>*	 %1704H48% *
Insert group selection  %1705M%	00-66	00-66	
		00*	 %1705D00% *

 %END%

3-18 Matrix 2 of 5

Read:

Format

Data digits (variable)	Check digit (optional)
------------------------	------------------------



















Check digit verification: The check digit is made as the sum module 10 of the numerical value of the data digits.

Check digit trans.: By setting Enable, check digit will be transmitted.

Max./Min. code length: Refer to [Max./Min. code length](#) of [3-15 Code 39 \(Code 32, Trioptic Code 39\)](#).

Code ID setting: Refer to [Code ID setting](#) of [3-10 UPC-A](#).

Insertion group selection: Refer to [Insertion group selection](#) of [3-10 UPC-A](#).

Multiple-scan setting			Single-scan setting
Option barcode	Option	Alpha. entry	
Read  %1801M%	Disable	00	 %1801D00%
	Enable	01*	 %1801D01% *
Check digit verification  %1802M%	Disable	00*	 %1802D00% *
	Enable	01	 %1802D01%
Check digit trans.  %1803M%	Disable	00*	 %1803D00% *
	Enable	01	 %1803D01%
Max. code length  %1804M%	00-99	00-99	
		99*	 %1804D99% *
Min. code length  %1805M%	00-99	00-99	
		06*	 %1805D06% *
Code ID setting  %1806M%	00-FF ₁₆ (ASCII)	00-FF ₁₆	
		<X>*	 %1806H58% *
Insert group selection  %1807M%	00-66	00-66	
		00*	 %1807D00% *
 %END%			

3-19 Codabar

Read:

Format

Start character	Data digits (variable)	Check digit (optional)	End character
-----------------	------------------------	------------------------	---------------

Check digit verification: The check digit is made as the sum module 16 of the numerical value of the data digits.

Check digit trans.: By setting Enable, check digit will be transmitted.

Max./Min. code length: Refer to [Max./Min. code length](#) of [3-15 Code 39 \(Code 32, Trioptic Code 39\)](#).















Code ID setting: Refer to [Code ID setting](#) of [3-10 UPC-A](#).















Insertion group selection: Refer to [Insertion group selection](#) of [3-10 UPC-A](#).

Start/End Type: Codabar has four pairs of Start/End Pattern; you may select one pair to match your application.

Start/End transmission: Refer to [Start/End transmission](#) of [3-15 Code 39 \(Code 32, Trioptic Code 39\)](#).

Start/End character equality: By setting Enable, the start and end character of a Codabar barcode must be the same.

Multiple-scan setting			Single-scan setting
Option barcode	Option	Alpha. entry	
Read  %1901M%	Disable	00	 %1901D00%
	Enable	01*	 %1901D01% *
Check digit verification  %1902M%	Disable	00*	 %1902D00% *
	Enable	01	 %1902D01%
Check digit trans.  %1903M%	Disable	00*	 %1903D00% *
	Enable	01	 %1903D01%
Max. code length  %1904M%	00-99	00-99	
		99*	 %1904D99% *
Min. code length  %1905M%	00-99	00-99	
		04*	 %1905D04% *
Code ID setting  %1906M%	00-FF ₁₆ (ASCII)	00-FF ₁₆	
		<N>*	 %1906H4E% *
Insert group selection	00-66	00-66	

Multiple-scan setting			Single-scan setting
Option barcode	Option	Alpha. entry	
 %1907M%		00*	 %1907D00% *
Start/End type  %1908M%	ABCD/ABCD	00*	 %1908D00% *
	abcd/abcd	01	 %1908D01%
	ABCD/TN*E	02	 %1908D02%
	abcd/tn*E	03	 %1908D03%
Start/End transmission  %1909M%	Disable	00*	 %1909D00% *
	Enable	01	 %1909D01%
Start/End character equality  %1910M%	Disable	00*	 %1910D00% *
	Enable	01	 %1910D01%
 %END%			

3-20 Code 128

Read:

Format

Data digits (variable)	Check digit (optional)
------------------------	------------------------

Check digit verification: The check digit is made as the sum module 103 of all data digits.

Check digit trans.: By setting Enable, check digit will be transmitted.

Max./Min. code length: Refer to [Max./Min. code length](#) of [3-15 Code 39 \(Code 32, Trioptic Code 39\)](#).

Code ID setting: Refer to [Code ID setting](#) of [3-10 UPC-A](#).

Insertion group selection: Refer to [Insertion group selection](#) of [3-10 UPC-A](#).

Truncate leading zeros: The leading "0" digits of Code 128 barcode characters can be truncated when the feature is enabled.

Multiple-scan setting			Single-scan setting
Option barcode	Option	Alpha. entry	
Read  %2001M%	Disable	00	 %2001D00%
	Enable	01*	 %2001D01% *
Check digit verification  %2002M%	Disable	00	 %2002D00%
	Enable	01*	 %2002D01% *
Check digit trans.  %2003M%	Disable	00*	 %2003D00% *
	Enable	01	 %2003D01%
Max. code length  %2004M%	00-99	00-99	
		99*	 %2004D99% *
Min. code length  %2005M%	00-99	00-99	
		01*	 %2005D01% *
Code ID setting  %2006M%	00-FF ₁₆ (ASCII)	00-FF ₁₆	
		<K>*	 %2006H4B% *
Insert group selection  %2007M%	00-66	00-66	
		00*	 %2007D00% *
Truncate leading zeros  %2008M%	Disable	00*	 %2008D00% *
	All leading "0"s	01	 %2008D01%
	Only the first "0"	02	 %2008D02%
 %END%			

3-21 UCC/EAN 128 (GS1-128)

Read:

Format

Data digits (variable)	Check digit (optional)
------------------------	------------------------

Check digit verification: The check digit is made as the sum module 103 of all data digits.























Check digit trans.: By setting Enable, check digit will be transmitted.

Max./Min. code length: Refer to [Max./Min. code length](#) of [3-15 Code 39 \(Code 32, Trioptic Code 39\)](#).

Code ID setting: Refer to [Code ID setting](#) of [3-10 UPC-A](#).

Insertion group selection: Refer to [Insertion group selection](#) of [3-10 UPC-A](#).

Truncate leading zeros: Refer to [Truncate leading zeros](#) of [3-19 Code 128](#).

Multiple-scan setting			Single-scan setting
Option barcode	Option	Alpha. entry	
Read  %2501M%	Disable	00	 %2501D00%
	Enable	01*	 %2501D01% *
Check digit verification  %2502M%	Disable	00	 %2502D00%
	Enable	01*	 %2502D01% *
Check digit trans.  %2503M%	Disable	00*	 %2503D00% *
	Enable	01	 %2503D01%
Max. code length  %2504M%	00-99	00-99	
		99*	 %2504D99% *
Min. code length  %2505M%	00-99	00-99	
		01*	 %2505D01% *
Code ID setting  %2506M%	00-FF ₁₆ (ASCII)	00-FF ₁₆	
		<K>*	 %2506H4B% *
Insert group selection  %2507M%	00-66	00-66	
		00*	 %2507D00% *
Truncate leading zeros  %2508M%	Disable	00*	 %2508D00% *
	All leading "0"s	01	 %2508D01%
	Only the first "0"	02	 %2508D02%
 %END%			

3-22 ISBT 128

Read:

Format

Data digits (variable)	Check digit (optional)
------------------------	------------------------







Check digit verification: The check digit is made as the sum module 103 of all data digits.

Check digit trans.: By setting Enable, check digit will be transmitted.

Max./Min. code length: Refer to [Max./Min. code length](#) of [3-15 Code 39 \(Code 32, Trioptic Code 39\)](#).

Code ID setting: Refer to [Code ID setting](#) of [3-10 UPC-A](#).

Insertion group selection: Refer to [Insertion group selection](#) of [3-10 UPC-A](#).

Multiple-scan setting			Single-scan setting
Option barcode	Option	Alpha. entry	
Read  %3301M%	Disable	00	 %3301D00%
	Enable	01*	 %3301D01% *
Check digit verification  %3302M%	Disable	00	 %3302D00%
	Enable	01*	 %3302D01% *
Check digit trans.  %3303M%	Disable	00*	 %3303D00% *
	Enable	01	 %3303D01%
Max. code length  %3304M%	00-99	00-99	
		99*	 %3304D99% *
Min. code length  %3305M%	00-99	00-99	
		01*	 %3305D01% *
Code ID setting  %3306M%	00-FF ₁₆ (ASCII)	00-FF ₁₆	
		<K>*	 %3306H4B% *
Insert group selection  %3307M%	00-66	00-66	
		00*	 %3307D00% *

 %END%

3-23 Code 93

Read:

Format

Data digits (variable)	2 Check digit (optional)
------------------------	--------------------------















Check digit verification: The check digit is made as the sum module 47 of all data digits.

Check digit trans.: By setting Enable, check digit will be transmitted.

Max./Min. code length: Refer to [Max./Min. code length](#) of [3-15 Code 39 \(Code 32, Trioptic Code 39\)](#).

Code ID setting: Refer to [Code ID setting](#) of [3-10 UPC-A](#).

Insertion group selection: Refer to [Insertion group selection](#) of [3-10 UPC-A](#).

Multiple-scan setting			Single-scan setting
Option barcode	Option	Alpha. entry	
Read  %2101M%	Disable	00	 %2101D00%
	Enable	01*	 %2101D01% *
Check digit verification  %2102M%	Disable	00	 %2102D00%
	Enable	01*	 %2102D01% *
Check digit trans.  %2103M%	Disable	00*	 %2103D00% *
	Enable	01	 %2103D01%
Max. code length  %2104M%	00-99	00-99	
		99*	 %2104D99% *
Min. code length  %2105M%	00-99	00-99	
		01*	 %2105D01% *
Code ID setting  %2106M%	00-FF ₁₆ (ASCII)	00-FF ₁₆	
		<L>*	 %2106H4C% *
Insert group selection  %2107M%	00-66	00-66	
		00*	 %2107D00% *
 %END%			

3-24 Code 11

Read:

Format

Data digits (variable)	Check digit 1 (optional)	Check digit 2 (optional)
------------------------	--------------------------	--------------------------

Check digit verification: The check digit is made as the sum module 11 of all data digits.

Check digit trans.: By setting Enable, check digit will be transmitted.

Max./Min. code length: Refer to [Max./Min. code length](#) of [3-15 Code 39 \(Code 32, Trioptic Code 39\)](#).

Code ID setting: Refer to [Code ID setting](#) of [3-10 UPC-A](#).

Insertion group selection: Refer to [Insertion group selection](#) of [3-10 UPC-A](#).

Multiple-scan setting			Single-scan setting
Option barcode	Option	Alpha. entry	
Read  %2201M%	Disable	00*	 %2201D00% *
	Enable	01	 %2201D01%
Check digit verification  %2202M%	Disable	00	 %2202D00%
	1 digit	01*	 %2202D01% *
Check digit trans.  %2203M%	Disable	00*	 %2203D00% *
	Enable	01	 %2203D01%
Max. code length  %2204M%	00-99	00-99	
		99*	 %2204D99% *
Min. code length  %2205M%	00-99	00-99	
		04*	 %2205D04% *
Code ID setting  %2206M%	00-FF ₁₆ (ASCII)	00-FF ₁₆	
		<V>*	 %2206H56% *
Insert group selection  %2207M%	00-66	00-66	
		00*	 %2207D00% *

 %END%

3-25 MSI/Plessey

Read:

Format

Data digits (variable)	Check digit 1 (optional)	Check digit 2 (optional)
------------------------	--------------------------	--------------------------







Check digit verification: The MSI/Plessey has one or two optional check digits. There are three methods of verifying check digits, i.e. Mod 10, Mod 10/10 Mod 10/11. The check digit 1 and check digit 2 will be calculated as the sum module 10 or 11 of the data digits.

Check digit trans.: By setting Enable, check digit will be transmitted.

Max./Min. code length: Refer to [Max./Min. code length](#) of [3-15 Code 39 \(Code 32, Trioptic Code 39\)](#).

Code ID setting: Refer to [Code ID setting](#) of [3-10 UPC-A](#).

Insertion group selection: Refer to [Insertion group selection](#) of [3-10 UPC-A](#).

Multiple-scan setting			Single-scan setting
Option barcode	Option	Alpha. entry	
Read  %2301M%	Disable	00*	 %2301D00% *
	Enable	01	 %2301D01%
Check digit verification  %2302M%	Disable	00*	 %2302D00% *
	1 digit (Mod 10)	01	 %2302D01%
	2 digits (Mod 10/10)	02	 %2302D02%
	2 digits (Mod 10/11)	03	 %2302D03%
Check digit trans.  %2303M%	Disable	00*	 %2303D00% *
	Enable	01	 %2303D01%
Max. code length  %2304M%	00-99	00-99	
		99*	 %2304D99% *
Min. code length  %2305M%	00-99	00-99	
		04*	 %2305D04% *
Code ID setting  %2306M%	00-FF ₁₆ (ASCII)	00-FF ₁₆	
		<O>*	 %2306H4F% *
Insert group selection  %2307M%	00-66	00-66	
		00*	 %2307D00% *
 %END%			

3-26 UK/Plessey

Read:

Format

Data digits (variable)	2 Check digits (optional)
------------------------	---------------------------

Check digit verification: The UK/Plessey has one or two optional check digits. The check digit 1 and check digit 2 will be calculated as the sum module 10 or 11 of the data digits.

Check digit trans.: By setting Enable, check digit will be transmitted.

Max./Min. code length: Refer to [Max./Min. code length](#) of [3-15 Code 39 \(Code 32, Trioptic Code 39\)](#).

Code ID setting: Refer to [Code ID setting](#) of [3-10 UPC-A](#).

Insertion group selection: Refer to [Insertion group selection](#) of [3-10 UPC-A](#).

Multiple-scan setting			Single-scan setting
Option barcode	Option	Alpha. entry	
Read  %2401M%	Disable	00*	 %2401D00% *
	Enable	01	 %2401D01%
Check digit verification  %2402M%	Disable	00	 %2402D00%
	Enable	01*	 %2402D01% *
Check digit trans.  %2403M%	Disable	00*	 %2403D00% *
	Enable	01	 %2403D01%
Max. code length  %2404M%	00-99	00-99	
		99*	 %2404D99% *
Min. code length  %2405M%	00-99	00-99	
		01*	 %2405D01% *
Code ID setting  %2406M%	00-FF ₁₆ (ASCII)	00-FF ₁₆	
		<U>*	 %2406H55% *
Insert group selection  %2407M%	00-66	00-66	
		00*	 %2407D00% *
 %END%			

3-27 China Post

Read:
Format

11 Data digits

Max./Min. code length: Refer to Max./Min. code length of 3-15 Code 39 (Code 32, Trioptic Code 39).

Code ID setting: Refer to Code ID setting of 3-10 UPC-A.

Insertion group selection: Refer to Insertion group selection of 3-10 UPC-A.

Multiple-scan setting			Single-scan setting
Option barcode	Option	Alpha. entry	
Read  %2601M%	Disable	00	 %2601D00%
	Enable	01*	 %2601D01% *
Max. code length  %2604M%	00-99	00-99	
		11*	 %2604D11% *
Min. code length  %2605M%	00-99	00-99	
		11*	 %2605D11% *
Code ID setting  %2606M%	00-FF ₁₆ (ASCII)	00-FF ₁₆	
		<T>*	 %2606H54% *
Insert group selection  %2607M%	00-66	00-66	
		00*	 %2607D00% *
 %END%			

3-28 China Finance

Note: This type of barcode is not Omni-Directionally decodable. The encodable character set includes numeric 0 to 9. Among the symbol of 0 to 9, 0 to 2, 4 and 9, 5 and 8, 6 and 7, have the symmetrical pattern; the pattern of 1 and 3 is symmetrical.

Read:

Format

10 Data digits

Max./Min. code length: Refer to Max./Min. code length of 3-15 Code 39 (Code 32, Trioptic Code 39).

















Check digit verification: The check digit is calculated as the sum module 10 of the data digits.















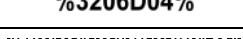
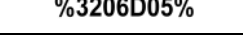

Leading character 5/6/7/8/9 converted to A/B/C/D/E: By setting, leading character 5/6/7/8/9 can be converted to A/B/C/D/E.

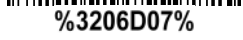
Leading character assignment: By setting, only barcode with the assigned leading character can be output.

Code ID setting: Refer to Code ID setting of 3-10 UPC-A.

Insertion group selection: Refer to Insertion group selection of 3-10 UPC-A.

Multiple-scan setting			Single-scan setting
Option barcode	Option	Alpha. entry	
Read  %3201M%	Disable	00	 %3201D00%
	Enable	01*	
Max. code length  %3202M%	00-99	00-99	 %3202D10% *
		10*	
Min. code length  %3203M%	00-99	00-99	 %3203D10% *
		10*	
Check digit verification  %3204M%	Disable	00*	 %3204D00% *
	Reserved	01	 %3204D01%
Leading character 5/6/7/8/9 converted to A/B/C/D/E  %3205M%	Disable	00	 %3205D00%
	Enable	01*	 %3205D01% *
	Only 5 converted to A	02	 %3205D02%
	Only 6 converted to B	03	 %3205D03%
	Only 7 converted to C	04	 %3205D04%
	Only 8 converted to D	05	 %3205D05%

Multiple-scan setting			Single-scan setting
Option barcode	Option	Alpha. entry	
	Only 9 converted to E	06	 %3205D06%
Leading character assignment  %3206M%	Disable	00	 %3206D00%
	Assigned to 0	01*	 %3206D01% *
	Assigned to 5 (A)	02	 %3206D02%
	Assigned to 6 (B)	03	 %3206D03%
	Assigned to 7 (C)	04	 %3206D04%
	Assigned to 8 (D)	05	 %3206D05%
	Assigned to 9 (E)	06	 %3206D06%
	Assigned to 1	07	 %3206D07%
	Assigned to 2	08	 %3206D08%
	Assigned to 3	09	 %3206D09%
	Assigned to 4	10	 %3206D10%
Code ID setting  %3207M%	00-FF ₁₆ (ASCII)	00-FF ₁₆	
		<Y>*	 %3207H59% *
Insert group selection  %3208M%	00-66	00-66	
		00*	 %3208D00% *
 %END%			

3-29 GS1 DataBar (GS1 DataBar Truncated)

GS1 DataBar Truncated is structured and encoded the same as the GS1 DataBar except that its height is reduced to a 13 modules minimum; while GS1 DataBar should have a height greater than or equal to 33 modules.

Read:

Format

16 Data digits

Code ID setting: Refer to [Code ID setting](#) of [3-10 UPC-A](#).

Insertion group selection: Refer to [Insertion group selection](#) of [3-10 UPC-A](#).

Conversion

UCC/EAN 128 - Refer to [Code ID transmission](#) of [3-42 String transmission](#),]Cm will be identified as AIM ID.

UPC-A or EAN-13 - Barcode beginning with a single zero as the first digit has the leading "010" stripped and the barcode reported as EAN-13. Barcode beginning with two or more zeros but not six zeros has the leading "0100" stripped and the barcode reported as UPC-A.

Multiple-scan setting			Single-scan setting
Option barcode	Option	Alpha. entry	
Read  %2701M%	Disable	00	 %2701D00%
	Enable	01*	
Code ID setting  %2702M%	00-FF ₁₆ (ASCII)	00-FF ₁₆	
		<R>*	 %2702H52% *
Insert group selection  %2703M%	00-66	00-66	
		00*	 %2703D00% *
Conversion  %2704M%	None	00*	 %2704D00% *
	UCC/EAN 128	01	 %2704D01%
	UPC-A or EAN-13	02	 %2704D02%
 %END%			

3-30 GS1 DataBar Limited

Read:
Format

16 Data digits

Code ID setting: Refer to [Code ID setting](#) of [3-10 UPC-A](#).

Insertion group selection: Refer to [Insertion group selection](#) of [3-10 UPC-A](#).

Conversion: Refer to [Conversion](#) of [3-29 GS1 DataBar\(GS1 DataBar Truncated\)](#).

Multiple-scan setting			Single-scan setting
Option barcode	Option	Alpha. entry	
Read  %2801M%	Disable	00	 %2801D00%
	Enable	01*	 %2801D01% *
Code ID setting  %2802M%	00-FF ₁₆ (ASCII)	00-FF ₁₆	
		<R>*	 %2802H52% *
Insert group selection  %2803M%	00-66	00-66	
		00*	 %2803D00% *
Conversion  %2804M%	None	00*	 %2804D00% *
	UCC/EAN 128	01	 %2804D01%
	UPC-A or EAN-13	02	 %2804D02%
 %END%			

3-31 GS1 DataBar Expanded















Read:
Format

Data digits (variable)

Code ID setting: Refer to [Code ID setting](#) of 3-10 UPC-A.

Insertion group selection: Refer to [Insertion group selection](#) of 3-10 UPC-A.

Conversion: Refer to [Conversion](#) of 3-29 GS1 DataBar(GS1 DataBar Truncated).

Multiple-scan setting			Single-scan setting
Option barcode	Option	Alpha. entry	
Read  %2901M%	Disable	00	 %2901D00%
	Enable	01*	 %2901D01% *
Max. code length  %2902M%	00-99	00-99	
		99*	 %2902D99% *
Min. code length  %2903M%	00-99	00-99	
		01*	 %2903D01% *
Code ID setting  %2904M%	00-FF ₁₆ (ASCII)	00-FF ₁₆	
		<R>*	 %2904H52% *
Insert group selection  %2905M%	00-66	00-66	
		00*	 %2905D00% *
Conversion  %2906M%	None	00*	 %2906D00% *
	UCC/EAN 128	01	 %2906D01%
 %END%			

3-32 GS1 Composite

GS1 Composite symbol group consists of two components: a linear component, which encodes the item's primary data; and an adjacent 2D composite component, which contains supplementary data.

The linear component will be a traditional symbol of types: GS-128, EAN-8, EAN-13, UPC-A, UPC-E or DataBar.

The composite component will be either a CC-A (encoding up to 56 digits), a CC-B (up to 338 digits) or a CC-C (up to 2361 digits).

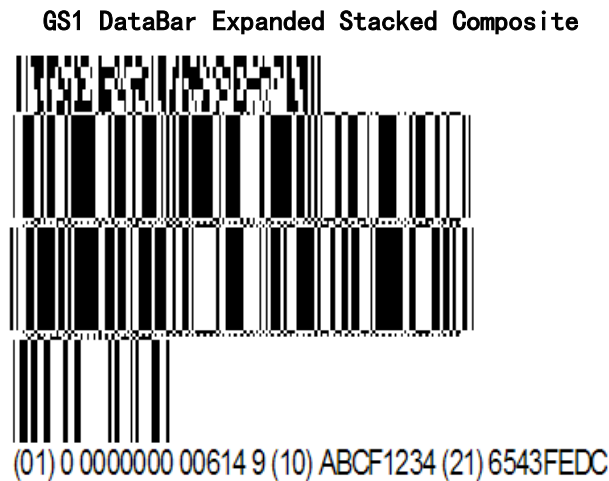





GS1 composite version enabled:

- ✓ **Note 1-** While this feature is enabled, the decode speed will be dropped. The more versions are enabled, the more obvious influence.
- ✓ **Note 2-** If the corresponding linear 1D barcode symbol is set disable, only 2D composite data will be output after a success decode.
- ✓ **Note 3-** While this feature is set disable, if the corresponding linear 1D barcode symbol is set enable, only 1D data will be output after a success decode.
- ✓ **Note 4-** For UPC/EAN Composite, if 2D composite component is failed to decode and 1D linear component is successful to decode, then only 1D data will be output.
- ✓ **Note 5-** If both GS-128 and DataBar Composite are set Enable, both 1D and 2D components must be successfully decoded to output both 1D and 2D data.

GS1-128 Composite, DataBar Composite - Two versions of GS1 Composite symbol are enabled.





GS1-128 Composite, DataBar Composite, UPC/EAN Composite - Three versions of GS1 Composite symbol are enabled.

Multiple-scan setting			Single-scan setting
Option barcode	Option	Alpha. entry	
GS1 composite version enabled  %3501M%	None (Disable)	00*	 %3501D00% *
	GS1-128 Composite, DataBar Composite	01	 %3501D01%
	GS1-128 Composite, DataBar Composite, UPC/EAN Composite	02	 %3501D02%
 %END%			

3-33 PDF417

Read:
Format





Data digits (variable)

Multiple-scan setting			Single-scan setting
Option barcode	Option	Alpha. entry	
Read  %3001M%	Disable	00	 %3001D00%
	Enable	01*	 %3001D01% *
 %END%			

3-34 MicroPDF417

Read:
Format





Data digits (variable)

Multiple-scan setting			Single-scan setting
Option barcode	Option	Alpha. entry	
Read  %3101M%	Disable	00*	 %3101D00% *
	Enable	01	 %3101D01%
 %END%			

3-35 QR Code

Read:
Format





Data digits (variable)

Multiple-scan setting			Single-scan setting
Option barcode	Option	Alpha. entry	
Read  %4001M%	Disable	00	 %4001D00%
	Enable	01*	 %4001D01% *
 %END%			

3-36 Micro QR

Read:
Format





Data digits (variable)

Multiple-scan setting			Single-scan setting
Option barcode	Option	Alpha. entry	
Read  %4501M%	Disable	00*	 %4501D00% *
	Enable	01	 %4501D01%
 %END%			

3-37 Data Matrix

Read:
Format





Data digits (variable)

Multiple-scan setting			Single-scan setting
Option barcode	Option	Alpha. entry	
Read  %4101M%	Disable	00	 %4101D00%
	Enable	01*	 %4101D01% *
 %END%			

3-38 Han Xin Code

Read:
Format





Data digits (variable)

Multiple-scan setting			Single-scan setting
Option barcode	Option	Alpha. entry	
Read  %4201M%	Disable	00*	 %4201D00% *
	Enable	01	 %4201D01%
 %END%			

3-39 Aztec Code

Read:
Format

Data digits (variable)

Multiple-scan setting			Single-scan setting
Option barcode	Option	Alpha. entry	
Read  %4301M%	Disable	00*	 %4301D00% *
	Enable	01	 %4301D01%
 %END%			

3-40 G1-G6 & C1-C2 & FN1 substitution string setting

Format of barcode data transmission:

Prefix	Code name	Preamble	Code ID	Code length	Code data	Code ID	Postamble	Suffix
--------	-----------	----------	---------	-------------	-----------	---------	-----------	--------

Suffix string setting: The <enter> key is represented indifferent ASCII when it is applied by different OS. For a Windows/DOS OS, <enter> is represented as <CR><LF> (0x0D 0x0A); for an Apple MAC OS, <enter> is represented as <CR> (0x0D); for a Linux/Unix OS, <enter> is represented as <LF> (0x0A).









Prefix/Suffix/Preamble/Postamble string setting: They are appended to the data automatically when a barcode is decoded.

Example: Add a symbol of “\$” as a prefix for all symbols.

Steps:

- 1) Scan the option barcode of **Prefix string setting**.
- 2) Use the ASCII table to find the value of \$ → 24.
- 3) Scan **2** and **4**.
- 4) Scan **%END%** barcode.

Scanning steps: Scan the following barcodes in order.

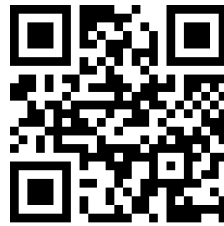
 %8001M%  2  4  %END%	 %8201M%  0  1  %END%	or	 %8001H24%8201D01%
--	--	----	---

Insert G1/G2/G3/G4 string setting: The engine offers 4 positions and 4 character strings to insert among a symbol.

Example: Set G1 string to be “AB”.

Original code data	“1 2 3 4 5 6”
Output code data	“1 2 A B 3 4 5 6”

Steps:

- 1) Scan the option barcode of **Insert G1 string setting**.
- 2) Use the ASCII table to find the value of A →41, B→42
- 3) Scan **4**, **1** and **4**, **2**.
- 4) Scan **%END%** barcode.
- 5) Refer to [3-41 G1-G4 string position & Code ID position](#).
- 6) Refer to [3-6 Scan mode & some global settings](#).



or

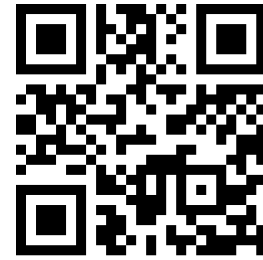

%8005H4142
%8101D02
%0407D01%

Testing barcode:



123456

FN1 substitution string setting: The FN1 character (0x1D) in an UCC/EAN128 barcode, or a Code 128 barcode, or a GS1 DataBar barcode can be substituted with a defined string.

Truncate leading G5 string setting: By setting, a defined leading character or string can be truncated. Also a single character can be un-defined.

Repeat of a G5 character setting: While G5 is set as a single defined or un-defined character, G5 can also be set to be repeated. This setting is ignored when the truncated number is more than the barcode data characters. The option of “FF” for this setting is not active while the option of Truncate leading G5 string setting is “00”.

Example: Truncate all leading zeros for all symbols.

Original code data	“0 0 0 1 2 3 4 5 6”
Output code data	“1 2 3 4 5 6”

Steps: scan the following data in order.



or



%8010H30
%8011HFF
%0407D05%

Testing barcode:



000123456

Truncate ending G6 string setting: By setting, a defined ending character or sting can be truncated. Also a single character can be undefined.

Repeat of a G6 character setting: While G6 is set as a single defined or undefined character, G7 can also be set to be repeated. This setting is ignored when the truncated number is more than the barcode data characters. The option of “FF” for this setting is not active while the option of Truncated ending G6 string setting is “00”.

Single character C1/C2 replacement: By setting, a defined character in the data string can be replaced by another defined character. The C1 and C2 replacement are applied simultaneously.

Example: Replace all the “A” character in a data string to be “B” character.

Original code data	“1 2 3 A 5 A”
Output code data	“1 2 3 B 5 B”

Steps: scan the following barcodes in order. The ASCII value for “A” is 41, and the ASCII value for “B” is 42.



or





1



4



2



%END%

%8014H4142%

Testing barcode:



123A5A

Multiple-scan setting			Single-scan setting
Option barcode	Option	Alpha. entry	
Prefix string setting  %8001M%	0-22 characters	00-FF ₁₆	 %8001H00% *
	None	00*	
Suffix string setting  %8002M%	0-22 characters	00-FF ₁₆	
	<ENTER>	0D0A*	
Preamble string setting  %8003M%	0-22 characters	00-FF ₁₆	 %8003H00% *
	none	00*	
Postamble string setting  %8004M%	0-22 characters	00-FF ₁₆	 %8004H00% *
	none	00*	
Insert G1 string setting  %8005M%	0-22 characters	00-FF ₁₆	 %8005H00% *
	none	00*	
Insert G2 string setting  %8006M%	0-22 characters	00-FF ₁₆	 %8006H00% *
	none	00*	
Insert G3 string setting  %8007M%	0-22 characters	00-FF ₁₆	 %8007H00% *
	none	00*	
Insert G4 string setting  %8008M%	0-22 characters	00-FF ₁₆	 %8008H00% *
	none	00*	
FN1 substitution string setting  %8009M%	0-4 characters	00-FF ₁₆	 %8009H20% *
	<SP>	20*	
Truncate leading G5 string setting  %8010M%	A un-defined character	00	 %8010H00%
	1-22 defined characters	01-7F ₁₆	

Multiple-scan setting			Single-scan setting
Option barcode	Option	Alpha. entry	
	<0>	30*	%8010H30% *
Repeat of a G5 character setting %8011M%	Defined times	01-22	
	Un-defined times (All)	FF	%8011HFF%
	Once	01*	%8011H01% *
Truncate ending G6 string setting %8010M%	1-22 defined characters	01-7F ₁₆	
	A un-defined character	00	%8012H00%
	<0>	30*	%8012H30% *
Repeat of a G6 character setting %8013M%	Defined times	01-22	
	Un-defined times (All)	FF	%8013HFF%
	Once	01*	%8013H01% *
Single character C1 replacement %8014M%	<0000>	0000*	
		0000-FFFF ₁₆	
Single character C2 replacement %8015M%	<0000>	0000*	
		0000-FFFF ₁₆	
%END%			

3-41 G1-G4 string position & Code ID position

Format of barcode data transmission:

Prefix	Code name	Preamble	Code ID	Code length	Code data	Code ID	Postamble	Suffix
--------	-----------	----------	---------	-------------	-----------	---------	-----------	--------

Insert G1/G2/G3/G4 string position: The engine offers 4 positions to insert strings among the symbol. In case of the insertion position is greater than the length of the symbol, the insertion of string is not affected.

Code ID position: It is allowed to select different positions of code ID placement.

Multiple-scan setting			Single-scan setting
Option barcode	Option	Alpha. entry	
Insert G1 string position  %8101M%	00-99	00-99	 %8101D00% *
		00*	
Insert G2 string position  %8102M%	00-99	00-99	 %8102D00% *
		00*	
Insert G3 string position  %8103M%	00-99	00-99	 %8103D00% *
		00*	
Insert G4 string position  %8104M%	00-99	00-99	 %8104D00% *
		00*	
Code ID position  %8105M%	Before code data	00*	 %8105D00% *
	After code data	01	 %8105D01%
 %END%			

3-42 String transmission

Note: The information in this chapter is closely related to [3-40 G1-G6 & C1-C2 & FN1 substitution string setting](#).

Format of barcode data transmission:

Prefix	Code name	Preamble	Code ID	Code length	Code data	Code ID	Postamble	Suffix
--------	-----------	----------	---------	-------------	-----------	---------	-----------	--------

Prefix transmission: By setting Enable, prefix will be appended before the data transmitted.

Suffix transmission: By setting Enable, suffix will be appended before the data transmitted.

Code name transmission: By setting Enable, code name will be transmitted before code data.

Preamble transmission: By setting Enable, preamble will be appended before the data transmission

Postamble transmission: By setting Enable, Postamble will be appended after the data transmission.

Code ID transmission: By setting Enable, Code ID can be transmitted in the format of either Proprietary ID or AIM ID. Refer to [1-2 Default setting for each barcode](#).

Code length transmission: The length of code data string can be transmitted before the code data transmitted when Enable is selected. The length is represented by a number with two digits.





Case conversion: The characters within code data or the whole output string can be set in either upper case or lower case.





FN1 substitution transmission: The engine supports a FN1 substitution feature. The replacement string of FN1 can be chosen by user (see [3-40 G1-G6 & C1-C2 & FN1 substitution string setting](#)).

All-non-printable-character string transmission with string setting: By setting Enable, all string settings, e.g. Preamble transmission or Insert G1 string setting, are active for an all-non-printable-character string. Here a non-printable character means a character with ASCII value between 0x00 to 0x1F.

Transmit the first N data characters only: The engine supports to only transmit the first N data characters of a barcode. The number of N can be set as a digit between 1 and 99.

Transmit the last N data characters only: The engine supports to only transmit the last N data characters of a barcode. The number of N can be set as a digit between 1 and 99.

Multiple-scan setting			Single-scan setting
Option barcode	Option	Alpha. entry	
Prefix transmission  %8201M%	Disable	00*	 %8201D00% *
	Enable	01	 %8201D01%
Suffix transmission  %8202M%	Disable	00*	 %8202D00% *
	Enable	01	 %8202D01%
Code name transmission  %8203M%	Disable	00*	 %8203D00% *
	Enable	01	 %8203D01%
Preamble transmission  %8204M%	Disable	00*	 %8204D00% *
	Enable	01	 %8204D01%
Postamble transmission  %8205M%	Disable	00*	 %8205D00% *
	Enable	01	 %8205D01%
Code ID transmission  %8206M%	Disable	00*	 %8206D00% *
	Enable	01	 %8206D01%
Code length transmission  %8207M%	Disable	00*	 %8207D00% *
	Enable	01	 %8207D01%
Case conversion  %8208M%	Disable	00*	 %8208D00% *
	Enable	01	 %8208D01%
FN1 substitution transmission  %8209M%	Disable	00*	 %8209D00% *
	Enable	01	 %8209D01%
All-non-printable-character string transmission with string setting  %8210M%	Disable	00*	 %8210D00% *
	Enable	01	 %8210D01%

Multiple-scan setting			Single-scan setting
Option barcode	Option	Alpha. entry	
Transmit the first N data characters only  %8211M%	01-99		 %8211D99% *
	All	99*	
Transmit the last N data characters only  %8212M%	01-99		 %8212D99% *
	All	99*	
 %END%			

4 Serial Communication Interface (SCI)

Note: The SCI programming commands can be used in place of the programming barcodes.

All communication between the engine and host occurs over the hardware interface lines using the Serial Communication Interface (SCI). The function of the SCI show as below:

- ✚ Maintain a bi-directional communication interface between the engine and the host.
- ✚ Allow the host to send commands to access the settings of the engine.
- ✚ Passes decoded data from the engine to the host.

In this section, the programming and query command syntax is described and examples of using commands to access the engine are presented.

4-1 Programming command syntax

4-1-1 Single-parameter setting

Format

Prefix	Parameter index	D/H	Value	Storage
--------	-----------------	-----	-------	---------

Prefix: <SYN> M <CR> (ASCII 0x16, 0x4D, 0x0D).

Parameter index: Each parameter has a unique 4-digit index which is similar to the option barcode listed in the “6 Parameter Menus”, except that there is no leading ‘%’ and ending “M%” in the Parameter index.

D/H: This is used by the image engine to identify the numeral system of Value. ‘D’ indicates a decimal number while ‘H’ indicates a hexadecimal number.

Value: This is generally a 2-digit number except for string-setting parameters, e.g. Prefix string setting.

Storage: A single character that specifies the storage area to which the command is applied to. An exclamation point ‘!’ performs the command’s operation on the volatile memory. A period ‘.’ performs the command’s operation on the device’s non-volatile memory. Using ‘!’ only when the setting needs to function through a single power cycle (Parameter value will be lost when power removed or the engine enters Standby mode).

Example1: Set 0401->03 (decimal). The command is as following.

Prefix	Parameter index	D	Value	.
0x16 0x4D 0x0D	0x30 0x34 0x30 0x31	0x44	0x30 0x33	0x2E

Example2: Set 8002->0D0A (hexadecimal). The command is as following.

Prefix	Parameter index	H	Value	.
0x16 0x4D 0x0D	0x38 0x30 0x30 0x32	0x48	0x30 0x44 0x30 0x41	0x2E

4-1-2 Multiple-parameter setting

Format

Prefix	Parameter index 1	D/H	Value 1	;	• • •	Parameter index N	D/H	Value N	Storage
--------	-------------------	-----	---------	---	-------	-------------------	-----	---------	---------

Prefix: Refer to Prefix of [4-1-1 Single-parameter setting](#).

Parameter index 1 to Parameter index N: Refer to Parameter index of [4-1-1 Single-parameter setting](#).

D/H: Refer to D/H of [4-1-1 Single-parameter setting](#).

Value 1 to Value N: Refer to Value of [4-1-1 Single-parameter setting](#).

Storage: Refer to Storage of [4-1-1 Single-parameter setting](#).

Example: Set 0401->03 (decimal), 8002->0D0A (hexadecimal). The command is as following.

Prefix	Parameter index	D	Value	;	Parameter index	H	Value	.
0x16 0x4D 0x0D	0x30 0x34 0x30 0x31	0x44	0x30 0x33	0x3B	0x38 0x30 0x30 0x32	0x48	0x30 0x44 0x30 0x41	0x2E

4-1-3 Query command syntax

Format

Prefix	Parameter index	^/?/*	.
--------	-----------------	-------	---

Prefix: Refer to Prefix of [4-1-1 Single-parameter setting](#).

Parameter index: Refer to Parameter index of [4-1-1 Single-parameter setting](#).

^/?/*: Several special characters can be used to query the image engine about its settings.

^ (0x5E)	Read the default value for the parameter
? (0x3F)	Read the current value for the setting.
* (0x2A)	Read the range of possible values for the parameter.

4-1-4 Start Decode & Stop Decode

Start Decode

Format

<SYN>	T	<CR>
0x16	0x54	0x0D

Activate the image engine to scan barcodes when Scan Mode is Host.

Stop Decode

Format

<SYN>	U	<CR>
0x16	0x55	0x0D

Deactivate the image engine to scan barcodes when Scan Mode is Host.

4-1-5 Return default parameters & firmware revision

Restore Factory Defaults

Format

<SYN>M<CR>	%%DEF	.
0x16 0x4D 0x0D	0x25 0x25 0x25 0x44 0x45 0x46	0x2E

Set the parameters to the factory default values.

Write to Customer Defaults

Format

<SYN>M<CR>	%%WCDF	.
0x16 0x4D 0x0D	0x25 0x25 0x57 0x43 0x44 0x46	0x2E

Write the current parameter setting to the customer default settings.

Restore Customer Defaults

Format

<SYN>M<CR>	%%RSDF	.
0x16 0x4D 0x0D	0x25 0x25 0x52 0x53 0x44 0x46	0x2E

Restore customer default settings to current settings. If failed, restore default settings.

Firmware Version List

Format

<SYN>M<CR>	%%VER	.
0x16 0x4D 0x0D	0x25 0x25 0x25 0x56 0x45 0x52	0x2E

Request the software revision string from the image engine.

4-1-6 Get Image

Original Image Ship

Format

<SYN>M<CR>	%OISHP	.
0x16 0x4D 0x0D	0x25 0x4F 0x49 0x53 0x48 0x50	0x2E

An image is taken whenever the scan operation is done. The last image is always stored in memory. The original image can be “shipped” by using the `%OISHP` command.

Down-sampled Image Ship

Format

<SYN>M<CR>	%DISHP	.
0x16 0x4D 0x0D	0x25 0x44 0x49 0x53 0x48 0x50	0x2E

An image is taken whenever the scan operation is done. The last image is always stored in memory. The down-sampled image can be “shipped” by using the `%DISHP` command.

4-1-7 Responses

The image engine responds to a serial command with one of three responses:

<ACK> (0x06)	A valid command which has been processed.
<ENQ> (0x05)	An invalid index command.
<NAK> (0x15)	A command with a valid parameter index and an invalid value.

4-2 Examples of setting and query commands

The following examples illustrate how a command should be constructed and transmitted to the image engine.

Example 1: Append prefix “1N” to all symbols

Step 1: Set Prefix string setting to be “1N”.

- 1) Look up the parameter table in the “6 Parameter Menus” and the ASCII table in the “11 ASCII table”. The target parameter index is “8001”.
- 2) Its numeral system is hexadecimal, indicated by ‘H’.
- 3) Using the ASCII table, “1N” is translated into “314E”.
- 4) Put all above parts and then append a prefix and a storage indicator ‘.’, thus, “<SYN>M<CR>8001H314E.” is the command.
- 5) Upon receiving command, image engine response with “8001H314E<ACK>”.

Host: <SYN>M<CR>8001H314E.

<SYN>M<CR>	8001	H	314E	.
0x16 0x4D 0x0D	0x38 0x30 0x30 0x31	0x48	0x33 0x31 0x34 0x45	0x2E

Image engine: 8001H314E

8001	H	314E	<ACK>
0x38 0x30 0x30 0x31	0x48	0x33 0x31 0x34 0x45	0x06

Step 2: Enable Prefix transmission.

- 1) Look up the parameter table in the “3 Parameter Menus” and the ASCII table in the 10 ASCII table. The target parameter index is represented by: “8201”.
- 2) The numeral system is decimal: ‘D’.
- 3) The value is translated as: ‘0’ and ‘1’.
- 4) Put all above parts and then append a storage indicator ‘.’ to construct the command: “<SYN>M<CR>8201D01.”
- 5) Upon receiving command, image engine response with “8201D01<ACK>”.

Host: <SYN>M<CR>8201D01.

<SYN>M<CR>	8201	D	01	.
0x16 0x4D 0x0D	0x38 0x32 0x30 0x31	0x44	0x30 0x31	0x2E

Image engine: 8201D01<ACK>

8201	D	01	<ACK>
0x38 0x32 0x30 0x31	0x44	0x30 0x31	0x06

Example 2: Query current scan mode

- 1) Look up the parameter table in the “6 Parameter Menus” and the ASCII table in the “11 ASCII table”.
The target parameter index is “0401”.
- 2) The numeral system is decimal, thus, ‘D’ is used.
- 3) The value field is filled with ‘?’.
- 4) Put all above parts and then append a storage indicator ‘.’ to construct the command:
“<SYN>M<CR>0401?.”.
- 5) Upon receiving command, image engine response with “0401D01<ACK>”.

Host: <SYN>M<CR>0401?.

<SYN>M<CR>	0401	?	.
0x16 0x4D 0x0D	0x30 0x34 0x30 0x31	0x3F	0x2E

Image engine: 0401D01<ACK>

0401	D	01	<ACK>
0x30 0x34 0x30 0x31	0x44	0x30 0x31	0x06

5 ASCII table

H L		for keyboard wedge		for RS-232	
		0	1	0	1
0		Null		NUL	DLE
1		Up	F1	SOH	DC1
2		Down	F2	STX	DC2
3		Left	F3	ETX	DC3
4		Right	F4	EOT	DC4
5		PgUp	F5	ENQ	NAK
6		PgDn	F6	ACK	SYN
7			F7	BEL	ETB
8		Bs	F8	BS	CAN
9		Tab	F9	HT	EM
A			F10	LF	SUB
B		Home	Esc	VT	ESC
C		End	F11	FF	FS
D		Enter	F12	CR	GS
E		Insert	Ctrl+	SO	RS
F		Delete	Alt+	SI	US

Notes: The 2nd and the 3rd columns above are used for keyboard wedge only.

H L	2	3	4	5	6	7
0	SP	0	@	P	`	p
1	!	1	A	Q	a	q
2	"	2	B	R	b	r
3	#	3	C	S	c	s
4	\$	4	D	T	d	t
5	%	5	E	U	e	u
6	&	6	F	V	f	v
7	'	7	G	W	g	w
8	(8	H	X	h	x
9)	9	I	Y	i	y
A	*	:	J	Z	j	z
B	+	;	K	[k	{
C	,	<	L	\	l	
D	-	=	M]	m	}
E	.	>	N	^	n	~
F	/	?	O	_	o	DEL

Example: ASCII "A" = "41".

6 Barcode representing non-printable character

Notes to make the following barcode:

- 1 According to different barcode printing software, the method of printing following barcode is different.
- 2 If using CODESOFT software, firstly read the information through "Help→Index→Code128→Special input syntax". Also refer to ASCII table. For example, if we wish to make "F1" barcode, select "Code128", then select "CODE A" type, and input "{DC1}" as data.



7 Test barcode symbols

UPC-A



UPC-E



UPC-E1

(Default setting: Read disable)



EAN-13



ISBN/ISSN



EAN-8



Code 39



Interleaved 2 of 5



Industrial 2 of 5

(Default setting: Read disable)



Matrix 2 of 5



库德巴码



Code 128



01AZ[+~*]za98

UCC/EAN 128



01AZ[]+-az54

ISBT 128



=1234 56789

Code 93



01AZ+~/*az89

Code 11

(Default setting: Read disable)



123456789-0

MSI/Plessey

(Default setting: Read disable)



0123456789

UK/Plessey

(Default setting: Read disable)



01ABEF89

China Post



01234567890

GS1 Databar (GS1 Databar Truncated)



(01) 12345678901231

GS1 Databar Limited



(01) 1 2345678 90126 2

GS1 Databar Expanded



Ab_09+yZ

PDF417



12=890ab-+%xyz

MicroPDF417

(Default setting: Read disable)



12345678abcABCMicroPDF417

QR code



1234567890ABCD-+(&*%^@#\$\$!XYZ

Micro QR Code

(Default setting: Read disable)



0123456789MicroQR

Data Matrix



123890abc-+&*%^!mdo

Aztec Code

(Default setting: Read disable)



12345678901234567890

Han Xin Code

(Default setting: Read disable)



1234567890Hanxin

8 Enable & Disable configuration by scanning barcode

Note: The setting of the below two barcodes does affect the operation of scanning the barcodes in 7 Return default parameters & firmware version.



Enable configuration by scanning barcode

The default status of the engine is enabled to scan configuration barcode.



Disable configuration by scanning barcode

Scan the above barcode to disable scanning configuration barcode except Enable configuration by scanning barcode and Disable configuration by scanning barcode. Then the engine will not operate configuration by scanning configuration barcodes, and the data string of configuration barcode will be displayed.

9 Return default parameters & firmware version



%%%DEF

WARNING: Restore Factory Defaults

Scan this barcode to restore the factory default values.



%%WCDF

Write to Custom Defaults

Store the current engine settings as custom defaults.



%%RSDF

Restore Custom Defaults

Restore the engine's custom default settings. If no custom defaults were set, restore the factory default values.



%%%VER

Firmware Version List

Scan this barcode to display the firmware version.

10 Configuration alphanumeric entry barcode



To finish parameter setting, please scan the bar code below.

